

# FG-CWP/FG-ACWP Series

## INSTRUCTION MANUAL

---

### Waterproof Digital Platform Scale

**FG-30KCMWP/FG-30KACMWP**

**FG-60KCLWP/FG-60KACLWP  
FG-150KCLWP/FG-150KACLWP**



## Warning definition

The warning definition described in this manual has the following meaning:

 DANGER	AN imminently hazardous situation which, if not avoided, will result in death or serious injury.
--	--

© 2022 A&D Company Ltd. All rights reserved.

No part of this publication may be reproduced, transmitted, transcribed, or translated into any language in any form by any means without the written permission of A&D Company Ltd.

The contents of this manual and the specifications of the instrument covered by this manual are subject to change for improvement without notice.

Windows, Word and Excel are registered trademarks of the Microsoft Corporation.

# Contents

<b>Contents</b> .....	<b>3</b>
<b>1. Compliance</b> .....	<b>5</b>
1.1. Compliance with FCC rules .....	5
1.2. Classification of Protection Provided by Enclosures .....	5
<b>2. Introduction</b> .....	<b>6</b>
<b>3. Outline and Features</b> .....	<b>6</b>
<b>4. Cautions</b> .....	<b>7</b>
4.1. Precautions for Installing the Scale .....	7
4.2. Precautions for Weighing.....	8
4.3. Precautions for Storing .....	8
<b>5. Items Included</b> .....	<b>9</b>
<b>6. Part Names</b> .....	<b>10</b>
6.1. Display and Symbols .....	11
6.2. Operation Keys .....	12
<b>7. Setup</b> .....	<b>14</b>
7.1. Attaching Pole to Base .....	14
7.2. Installation.....	14
<b>8. Basic Operation</b> .....	<b>15</b>
8.1. Turning Power On and Off.....	15
8.1.1. Mobile Battery (FG-CWP series (USB power model) only).....	16
8.2. Basic Operation .....	16
8.3. Readability .....	17
<b>9. Counting Function</b> .....	<b>17</b>
<b>10. Comparator Function</b> .....	<b>18</b>
10.1. How to Operate.....	19
10.2. Selecting the Memory Number .....	19
10.3. Checking the HI/LO Value .....	20
10.4. Setting HI/LO value.....	21
<b>11. Display Hold Function</b> .....	<b>22</b>
<b>12. Impact Shock Detection Function (ISD)</b> .....	<b>22</b>
<b>13. Auto-Tare Function</b> .....	<b>23</b>
<b>14. Sensitivity Adjustment</b> .....	<b>24</b>
14.1. Sensitivity Adjustment Items .....	24
14.2. Sensitivity Adjustment Using a Weight .....	26
14.3. Correcting for Gravitational Acceleration .....	27
14.4. Restoring Sensitivity Adjustment Value to Factory Default.....	28
<b>15. Function Table</b> .....	<b>29</b>
15.1. Parameter Setting Procedure .....	29

15.2. <i>Func</i> setting .....	29
15.2.1. Setting Example .....	30
15.3. <i>id</i> setting .....	30
15.4. <i>passwd</i> setting .....	30
15.5. Restoring Function Tables to Factory Default.....	31
15.6. Parameter List .....	32
<b>16. Communication .....</b>	<b>36</b>
16.1. USB Interface (FG-CWP series (USB power model) only ).....	36
16.2. Data Format.....	38
<b>17. Options .....</b>	<b>44</b>
17.1. Option List.....	44
<b>18. ID Number and GMP, GLP .....</b>	<b>45</b>
18.1. ID Number Setting Procedure .....	45
18.2. GMP, GLP Report .....	46
<b>19. Password Lock Function .....</b>	<b>50</b>
19.1. Setting Procedure .....	50
19.2. To Changing the Function Table After setting <i>Lock 1</i> or <i>2</i> .....	51
19.2.1. To Changing the Function Table in <i>Admin</i> .....	51
19.2.2. To Changing the Function Table in <i>GUEST</i> .....	52
19.2.3. List of Parameters that can be Changed in <i>GUEST</i> .....	52
19.2.4. Forgotten Password .....	53
<b>20. Legal-for-Trade mode instructions .....</b>	<b>54</b>
<b>21. Maintenance .....</b>	<b>56</b>
21.1. Repair .....	56
21.2. Error display.....	56
21.3. Error Code Table.....	57
<b>22. Specifications .....</b>	<b>58</b>
22.1. Specifications List.....	58
22.2. Dimensions .....	59
Gravity Acceleration Map .....	60



## 1. Compliance



### 1.1. Compliance with FCC rules

- Please note that this equipment generates, uses and can radiate radio frequency energy. This equipment has been tested and has been found to comply with the limits of Class A digital devices pursuant to Part 15 of FCC rules. These rules are designed to provide reasonable protection against interference when equipment is operated in a commercial environment. If this unit is operated in a residential area, it may cause some interference and under these circumstances the user would be required to take, at his own expense, whatever measures are necessary to eliminate the interference.

(FCC = Federal Communications Commission in the U.S.A.)



### 1.2. Classification of Protection Provided by Enclosures

- This equipment complies with the IP Code IEC 60529.  
The meaning of the IP67 code is as follows:  
IP :International Protection.  
6 :Protection against ingress of dust and airborne particles.  
7 :Protection against water and liquids, up to and included submersion of up to one meter.



## 2. Introduction

Thank you for purchasing this A&D Water proof digital platform scale. This manual describes how the FG-CWP/FG-ACWP Series Water proof digital platform Scales work and how to maximize their performance. Please read this manual completely before using the scale.



## 3. Outline and Features

The FG-CWP/FG-ACWP series has the following features.

- The scale is made of all stainless steel and has waterproof/dustproof performance compliant with IP67.  
(Intrusion of water into the device is prevented even when submerged to a depth of 1 m for 30 minutes.)
- The FG-CWP/FG-ACWP series has four display resolutions: 1/3,000, 1/6,000 (1/7,500 with some models), 1/12,000 (1/15,000 with some models), and 1/30,000. Resolution can be switched as needed for the usage. (Resolution = Readability / Weighing capacity)  
Note: The display resolution of the Legal for Trade models is fixed. The selection in the function setting is not available.
- The FG-CWP/FG-ACWP series has two sizes of weighing pans: M size for FG-30KCMWP/FG-30KACMWP and L size for FG-60KCLWP/FG-60KACLWP/FG-150KCLWP/FG-150KACLWP.
- The scales use a backlit liquid crystal display to enable viewing in dim light.
- For the FG-CWP series (USB power model), power is supplied via USB. You can use an AC adapter or a mobile battery. You can also send weighing data to a PC using a USB cable.
- Weighing data can be transmitted to a PC using the FG-27CWP option.(AD-8541-PC is required separately).
- **9.Counting Function** determines the number of objects based on the mass value (total weight) when each item has the same mass value.
- **10.Comparator Function** compares the displayed value (measured value) with the previously set comparator values and indicates the results on the large and bright LED display.
- Up to 10 comparator value settings can be stored in memory.
- **11.Display hold function** fixes display the weighed value in place to facilitate reading.
- **12.Impact shock detection function (ISD)** displays the shock level applied to the mass sensor section.
- **13.Auto-tare function**, used with comparator mode, automatically tares and displays “OK” for a certain amount of sample and repeats this process for the next weighing.
- The following parameters are stored in the scale even if the power is turned off.

Unit weight of counting function
HI/LO values of comparator function
Sensitivity adjustment data
Parameters of the function table



## 4. Cautions



### 4.1. Precautions for Installing the Scale

#### **DANGER**

- Ground the scale, so that the user will not be subjected to an electric shock.
- To prevent electric shock, do not handle the USB cable / AC cable with wet hands.
- The USB plug is not water-resistant. Use a USB outlet located at a place where the plug will not get wet. (For FG-CWP series (USB power model))
- The AC plug is not water-resistant. Use an electrical outlet located at a place where the plug will not get wet. (For FG-ACWP series (AC power model))
- Do not install the scale where flammable or corrosive gas is present.
- Do not put excessive force on cables.
- The scale is heavy. Use caution, as lifting may cause it to fall over.

#### **Consider the following installation conditions to get the greatest performance from your scale.**

- Install the scale in an indoor location out of direct sunlight with stable temperature and humidity that is free of drafts and vibrations, on a solid and level surface and with a stable power supply.
- Do not install on a soft floor or where there is vibration.
- Do not install where there is wind or large fluctuations in temperature.
- Avoid locations in direct sunlight.
- Do not install in locations with strong magnetic fields or strong radio signals.
- Do not install where static electricity is likely to occur. When humidity is 45% R.H. or less, plastic and insulating materials are apt to be charged with static electricity due to friction, etc.
- In general, insulating materials such as plastics tend to become electrostatically charged when the humidity is 45% RH or less, and errors due to static electricity may occur during weighing. Take the following actions as necessary. Also, ground the scale using the ground terminal.
  - Increase the relative humidity of the installation site.
  - Weigh the object by placing it in a conductive metal container.
  - Wipe charged objects such as plastics with a damp cloth to reduce static electricity.
  - Use a static eliminator (sold separately: AD-1683A, etc.) to directly remove static electricity from the object weighed.
- Unstable AC power supply may cause malfunctions.
- Remove the protective film from the weighing pan before use.
- This device is for indoor use only. When used outdoors, lightning surges that exceed the discharge capacity of this device may be received. In that case, this device will not be able to withstand the lightning energy and may be damaged.
- Sensitivity adjustment should be performed for more accurate weighing when the scale is first installed or when it is moved far. Refer to “[14. Sensitivity Adjustment](#)” for details.



## 4.2. Precautions for Weighing

- Do not place loads on the weighing pan that exceed the weighing capacity.
- Periodic sensitivity adjustment is recommended in order to maintain accurate weighing. (Refer to “14. Sensitivity Adjustment”)
- Do not apply shock to or drop anything on the weighing pan.
- Do not use a sharp instrument such as a pencil or pen to press keys or switches.
- Press the **ZERO** key before each weighing to reduce the chance of error.
- Do not weigh when the scale is immersed in water.
- Periodically confirm that weighed values are correct.
- The panel on the rear of the display unit should be kept closed during use to ensure it is dustproof and water proof.



## 4.3. Precautions for Storing

- Do not disassemble the scale.
- If the scale becomes dirty, wipe it with a soft cloth slightly moistened with a mild detergent or a rubbing alcohol (70% or less). Do not use organic solvents.
- Do not scrub with a brush or the like.
- Do not spray with strong jets of water.



# 5. Items Included

The following items are packed.

## <FG-CWP series (USB power model)>

- Main Unit

FG-30KCMWP

FG-60KCLWP

FG-150KCLWP

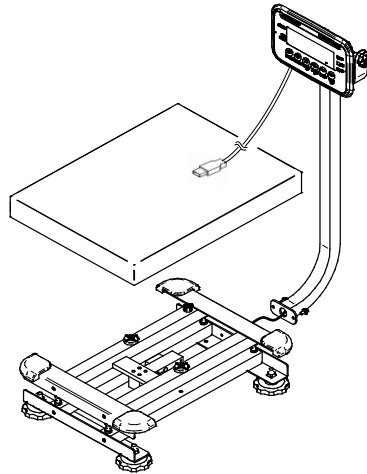
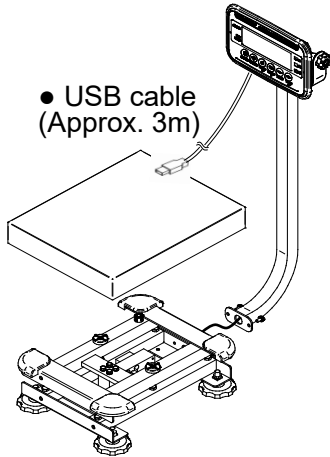

- Quick Start Guide



- AC Adapter



(Image diagram)

## <FG-ACWP series (AC power model)>

- Main Unit

FG-30KACMWP

FG-60KAACLWP

FG-150KAACLWP

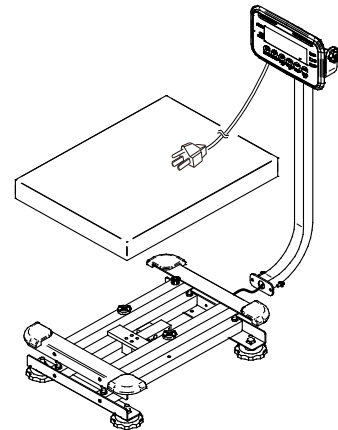
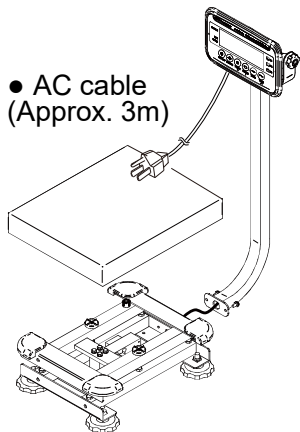

- Quick Start Guide

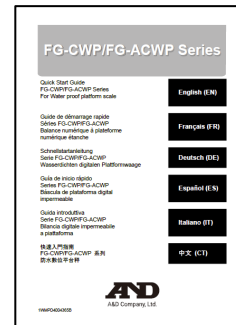



## 6. Part Names

### <FG-CWP series (USB power model)>

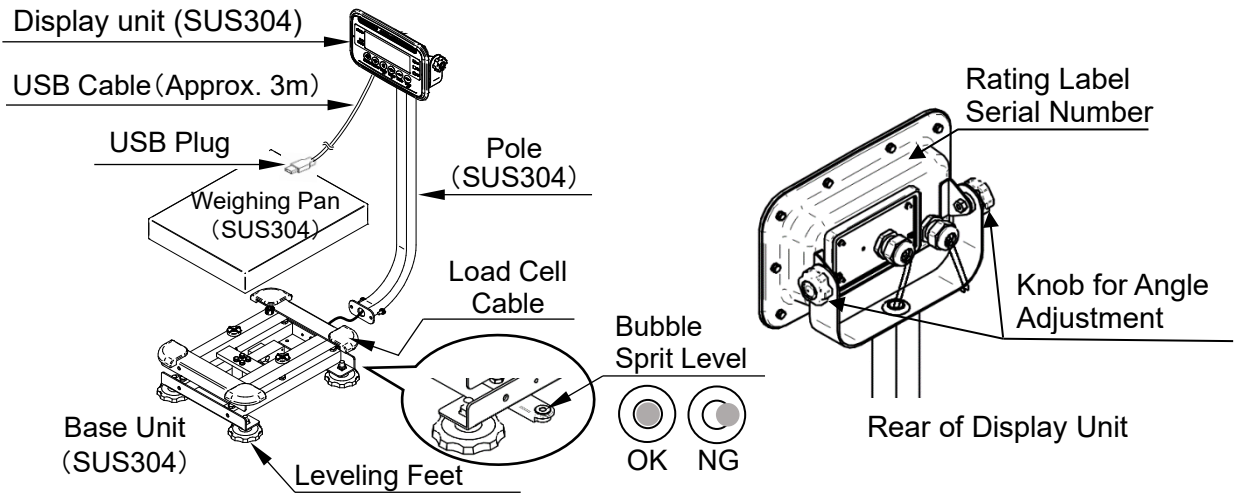

### <FG-ACWP series (AC power model)>

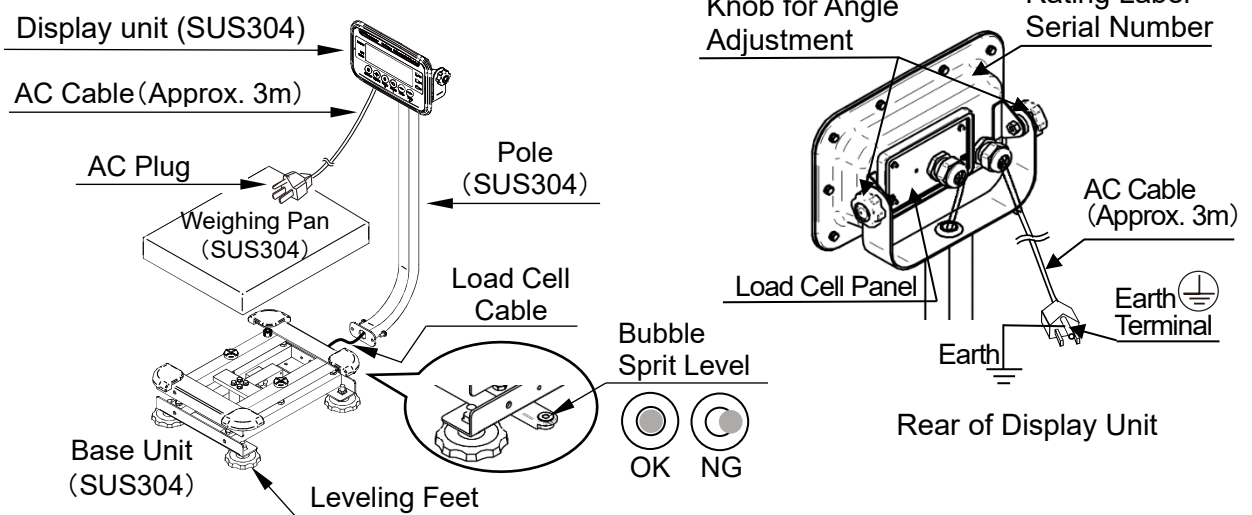



## 6.1. Display and Symbols

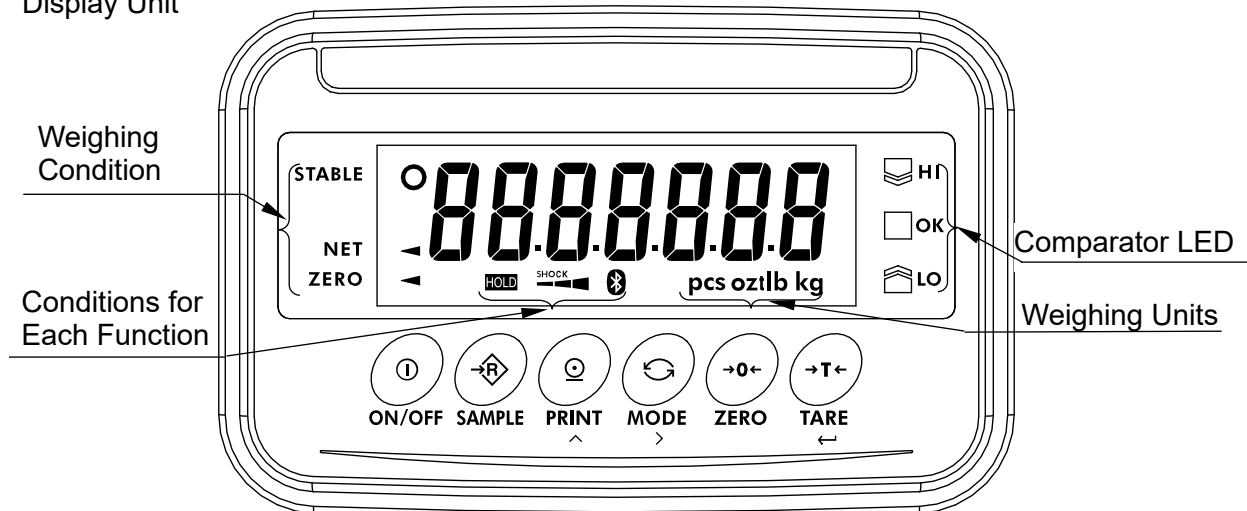

Display Unit



Display/symbol	Description
STABLE ○	This is lit when the weighed value is stable, indicating that the scale is in the proper condition for reading weighed values.
NET ◀	This is lit when weight of the container (tare) is subtracted.
ZERO ◀	This is lit when the scale is at the zero point (reference point for weighing).
Weighing Units	“kg”, “g”, “pcs”, “oz” and “lb” is lit. Note: “g” is only used with the FG-30KCMWP/FG-30KACMWP.
<b>HOLD</b>	This is lit when the display is held.
SHOCK ◀▶	This is a function to detect impact to the mass sensor section and to display the impact level.
	Lights up when successfully connected to the optional FG-27CWP (Bluetooth communication interface).
  	While the comparator function is being used, the weighed value is compared using the preset threshold values and the indicator displays the result.
	Alternating current.
	Earth (ground) Terminal.

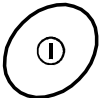

## 6.2. Operation Keys

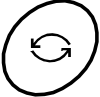
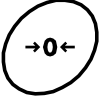
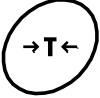
Operation key	Description
 ON/OFF	<b>ON/OFF Key</b> Shows or hides the display. Note: When the power plug of the scale is connected, power is supplied to the electric circuits inside the scale.
 SAMPLE	<b>SAMPLE Key</b> Selecting "pcs" as the unit activates individual weight setting mode. Pressing and holding (for about 2 seconds) activates comparator threshold setting mode.
 PRINT	<b>PRINT Key</b> Outputs the weighed value as data. Increases the value of the digit flashing when setting.
 MODE	<b>MODE Key</b> Switches the weighing unit. Shifts to the right the digit flashing when making settings.
 ZERO	<b>ZERO Key</b> Performs zeroing operation. (See below.)
 TARE	<b>TARE Key</b> Performs tare operation. (See below.) Saves the set value and proceeds to the next item when setting.

### Zeroing operation

With the zero point gained when turning on the display (power on zero function) as reference, pressing the **ZERO** key when the weighed value is stable within  $\pm 2\%$  of the weighing capacity sets the zero point there and the zero point indicator ◀ is lit when zero is displayed. If tare function is in use, the net is deleted.

### Tare function

Pressing the **TARE** key when the weighed value is a stable positive value subtracts the weight of the item on the weighing pan as the weight of the container (tare) weight. The displayed value becomes zero value and both the zero point indicator ◀ and net indicator ▶ are lit.

If the container (tare) is removed from the weighing pan while the tare function is in use and the value returns to the zero point, net is displayed as a negative value.

Note: The weighing range is reduced by the amount of the tare mass.

### Power on Zero Function

Power on zero is a function that displays zero along with the zero point indicator ◀ when the display is turned on by the **ON/OFF** key with nothing on the weighing pan.

The power on zero function can be used within a range  $\pm 50\%$  ( $\pm 10\%$  for the Legal for Trade models) of weighing capacity from zero during sensitivity adjustment.

## Power on Tare Function

Power on Tare is a functions where, when the power is turned on by pressing the ON/OFF key while something is placed on the weighing pan, taring is performed, the zero point indicator ◀ and the net indicator ◀ light up, and zero is displayed. The range in which power on tare is executed is +50% (+10% for the Legal for Trade models) or more of the weighing capacity with respect to zero during sensitivity adjustment.

※Less than  $\pm 50\%$  ( $\pm 10\%$  for the Legal for Trade models) of weighing capacity: Power on zero (zero point indicator ◀ lit)

※+50% (+10% for the Legal for Trade models) or more of weighing capacity: Power on tare (zero point indicator ◀ and net indicator ◀lit)

Note: If a tare or similar device is used on the weighing pan before weighing starts (power on), weighing performance may be affected.



## 7. Setup



### 7.1. Attaching Pole to Base

1. Take the base unit and the pole out of the packaging box while being careful not to pull the load cell cable.
2. Remove the weighing pan from the base.
3. Assembling the pole  
Temporarily remove the screws attached to the bottom of the weighing base, and then fasten the pole and base with the removed screws, taking care that the load cell cable is not pinched.  
Bundle and insert the excess load cell cable into the pole from the display side.
4. Put the weighing pan on the base unit.

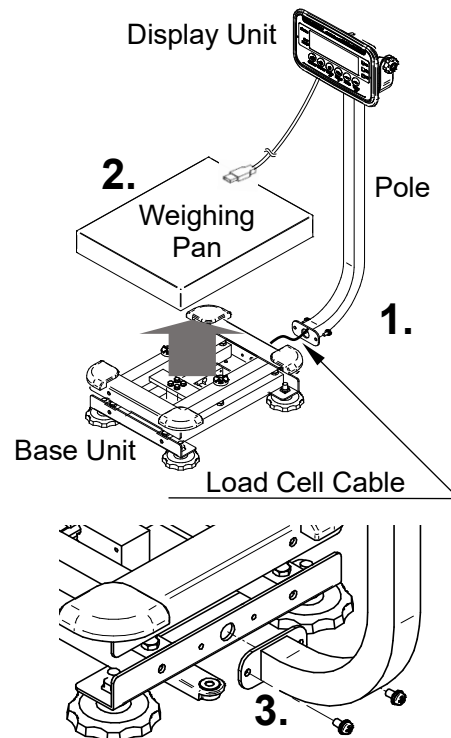

### 7.2. Installation

1. Decide where to install the scale by considering the descriptions of "[4.1. Precautions for Installing the Scale](#)".
2. Level the base unit by adjusting the four leveling feet of the base unit so that the bubble of the spirit level is centered
3. Follow the procedure below to change the display unit angle.
  - (1) Turn the two knobs (display unit knobs) on the rear of the display unit and remove them.
  - (2) Tilt the display unit to the desired angle.
  - (3) Replace and tighten the display unit knobs removed in step 1.

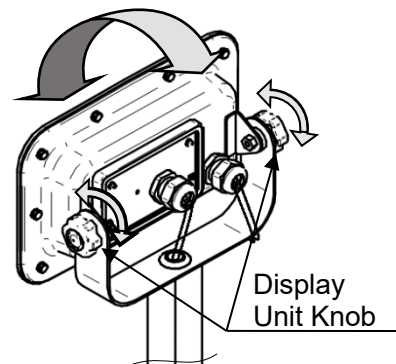
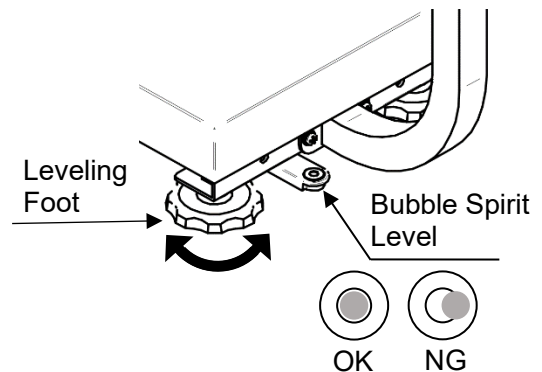

 If using the scale in a location where static electricity is easily generated or where it may get wet, secure the grounding wire with the earth (ground) terminal (M4 screw).

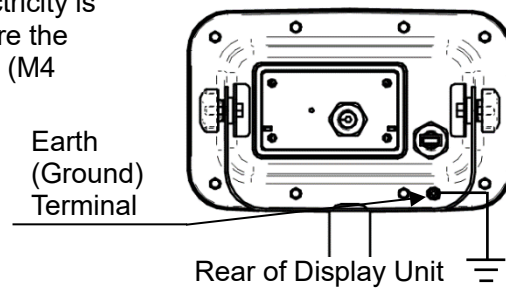

## 8. Basic Operation



### 8.1. Turning Power On and Off

#### 1. Connecting to power supply

<For FG-CWP series (USB power model)>

Insert the USB plug into the AC adapter included with this product and connect it to the power supply.

- Confirm that local voltage and receptacle type are correct.
- AC adapters other than the one supplied with this product may also be used. It can also be powered via the USB port or with a mobile battery.

Note: Not all operations are guaranteed.

- When using this device for "Legal for trade" or "Certification" measurement, use the included AC adapter.
- The USB cable is used for both power and communication.

<For FG-ACWP series (AC power model)>

- Insert the AC plug into a grounded outlet.
- Ground the scale using the earth terminal in order to prevent electric shock.
- Power is supplied only from the outlet.

2. Pressing the **ON/OFF** key turns on the display. All indications are lit and the scale waits for the weighed value to stabilize.

- is displayed when the display is turned on when the weighed value is not stable. Refer to "21.2. Error display".

#### Automatic Power On Function

The scale automatically turns on when power is supplied. See the "15.6. Parameter List" and set to **P-on I**.

3. Pressing the **ON/OFF** key while the scale is on turns off the scale.

#### Automatic Power Off Function

This function turns the display off when the specified interval has passed, the weighed value is stable and there is no key operation. See the "15.6. Parameter List" and set to

**PoFF I**.



## 8.1.1. Mobile Battery (FG-CWP series (USB power model) only)

If using a mobile battery

- Turn off the scale and disconnect the AC adapter if using a mobile battery.
- Connect the USB plug to the mobile battery. Refer to "15. Function Table" to set the function table .
- The continuous usage time is approximately 77 hours at 10000 mAh with the backlight on. This value is for reference only
- Do not set the .

### Cautions on using the mobile battery

- Check the battery level with your mobile battery.
- Not guaranteed to work with all mobile batteries.
- Confirm the mobile battery's specifications before use. The warranty does not cover malfunctions caused by use of a mobile battery.



## 8.2. Basic Operation

1. Press the  key to turn on the scale.  
Operation will start with the weighing unit used when the power was last turned off.
2. Use the  key to select the weighing unit to use.
3. If the display is not zero, press the  key to zero the display.
4. If using a container (tare), place that on the weighing pan and press the  key to zero the display.
5. Place the object to weigh on the weighing pan or in the container, wait for the stability indicator to light up, and then read the displayed value.
6. Remove the object weighed from the weighing pan.

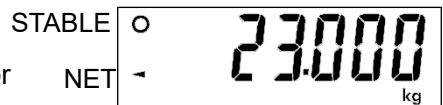
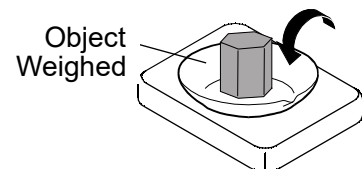
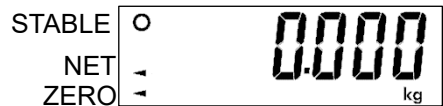
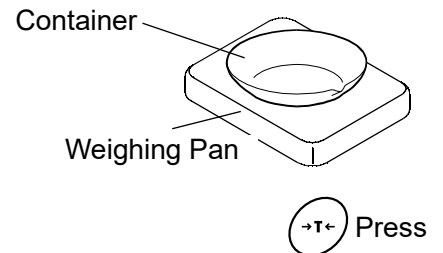

- Weighing can be done from zero to weighing capacity, but the tare weight is subtracted from the weighing capacity for the zero point after using the tare function.
- The  key and  key work after the weighed value is stable.



## 8.3. Readability

Mass can be displayed on FG-CWP/FG-ACWP series with the following four types of readability (scale interval or "division"). The ratio of readability and weighing capacity expressed as display resolution is shown in the following table.

Function table	Display resolution
(low resolution)	1/3000
(normal resolution)	1/6000 or 1/7500
(high resolution)	1/12000 or 1/15000
(max resolution)	1/30000

Readability is set to normal resolution at time of shipping. It can be changed in the function table item as needed for the usage environment. See "15. Function Table" for details on how to configure the settings.

- The display resolution of the Legal for Trade models is fixed. The selection in the function setting "" is not available.
- Calculation to display the count in counting mode is done at max resolution regardless of the set display resolution.



## 9. Counting Function

This function stores the mass (unit weight) of a single item from a known number of sample masses, and calculates and displays the number of items based on that value and the total mass.

- The unit mass is stored in non-volatile memory even when power is turned off.
1. Press the key to display the weighing unit "pcs".  
(pcs = pieces)
  2. Display the unit mass stored by pressing the key. The figure on the left is the sample count.
  3. Press the key to change the sample count. Select from 5, 10, 20, 50 and 100 pcs.
  4. When "-" appears at the right side of the number of samples, press the key to zero the scale. If necessary, place a container on the weighing pan, and press the key. Confirm that the right side of the number of samples shows zero.
  5. Place the number of samples shown on the weighing pan or into the container.

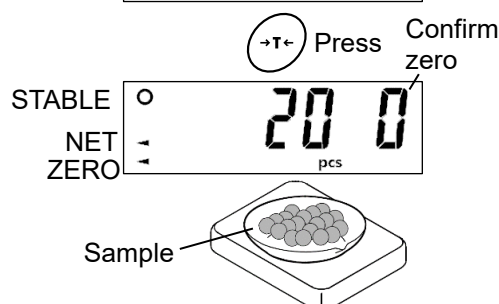
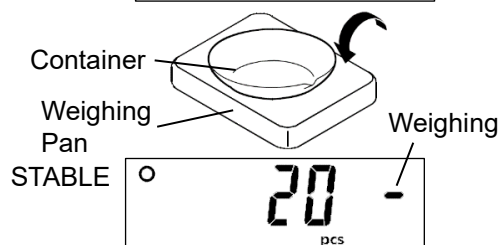
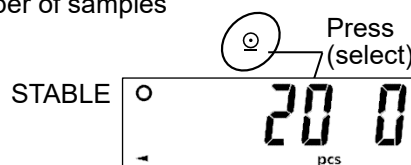
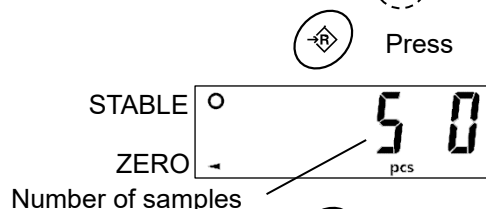
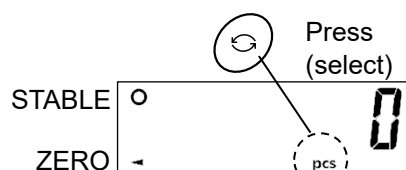

6. Confirm that the stability indicator is lit, and then press the **SAMPLE** key to calculate and store the unit mass. The display changes to the count using the unit mass stored. Remove the sample.

- The mass of the number of samples must be at least the values below, regardless of the sample count.

Weighing capacity	Minimum mass
FG-30KCMWP/FG-30KACMWP	10g
FG-60KCLWP/FG-60KACLWP	20g
FG-150KCLWP/FG-150KACLWP	50g

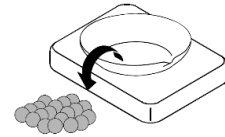
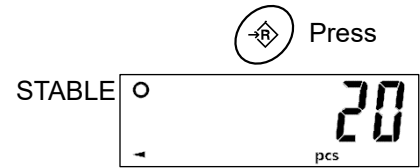

If the sample mass is small, **La ut** is displayed and returns to the display in step 5. Increase the number of samples (see step 3) and try again.

- If you press the **SAMPLE** key without reaching the minimum mass in the table above, you will be returned to weighing mode.



## 10. Comparator Function

The comparator function compares the weighed value against the set values and displays the results using LEDs (yellow / green / red). Comparison is done based on the following table, and the results are displayed/output.

Judgment result	Judgment formula	LED Display
HI	HI limit value < Displayed value (Or when positive value)	Yellow
OK	LO limit value ≤ Displayed value ≤ HI limit value	Green
LO	Displayed value < LO limit value (Or when negative value)	Red

- Select the comparison condition in function table item **[F P]**. (Refer to "15. Function Table")

Function table	Content
<b>[F P 0]</b>	No comparison (comparator function unavailable).
<b>[F P 1]</b>	All weighed values are compared regardless of stability.
<b>[F P 2]</b>	All stable weighed values are compared.
<b>[F P 3]</b>	Weighed values except those at -4d to +4d are compared regardless of stability
<b>[F P 4]</b>	All stable weighed values except those at -4d to +4d are compared.
<b>[F P 5]</b>	Weighed values +5d and above are compared regardless of stability.
<b>[F P 6]</b>	Stable weighed values at +5d and above are compared.

d= readability (scale interval or "division") (see the "basic manual" included with the product)

Even in the counting function, "d" is the readability in the mass display.

- The HI/LO values are stored in non-volatile memory even when power is turned off.
- The HI/LO values are the same in both mass display and count display.
- The decimal point is ignored for HI/LO values.

When parameter is "001000" with the FG-30KCMWP/FG-30KACMWP (decimal point ignored)

Display	Parameter	Weighing capacity / Readability display
Low resolution	10.00 kg	30.00 kg / 0.01 kg
Normal resolution	1.000 kg	30.000 kg / 0.005 kg
High resolution	1.000 kg	30.000 kg / 0.002 kg
Max resolution	1.000 kg	30.000 kg / 0.001 kg
Counting mode	1000 pcs	



## 10.1. How to Operate

1. Press and hold the **[SAMPLE]** key while in mass display to enter comparator setting mode.
2. Display the selected memory number (0-9).
3. Each time the **[PRINT]** key is pressed, the memory number display will be switched. The currently selected memory number is indicated by the "o" mark being lit.

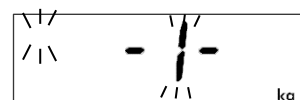
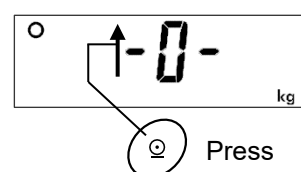

## 10.2. Selecting the Memory Number

1. Press and hold the **[SAMPLE]** key while in mass display to enter comparator setting mode and push the **[PRINT]** key to change the memory number display.
2. Press the **[TARE]** key to change the memory number. After displaying **End**, the device returns to weighing mode.
3. Start comparing using the memory number changed to.

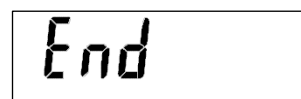
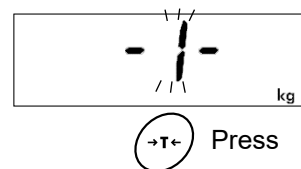



## 10.3. Checking the HI/LO Value

1. Press and hold the **SAMPLE** key while in mass display to enter comparator setting mode and push the **PRINT** key to change the memory number display.
2. Press the **MODE** key. LO is lit and the lower limit value of the memory number selected is displayed.
3. Press the **MODE** key. HI is lit and the upper limit value of the memory number selected is displayed.
4. To return to the memory number display, press the **MODE** key.
5. To return to weighing mode, press the **TARE** key. (Start comparing using the memory number displayed at this time.)

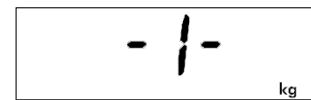
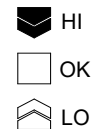
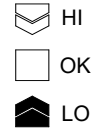



## 10.4. Setting HI/LO value

1. Press and hold the **SAMPLE** key while in mass display to enter comparator setting mode and push the **PRINT** key to change the memory number display.
2. Press the **MODE** key. LO is lit and the lower limit value is displayed.
3. Press the **TARE** key. The digit of the value blinks. Change the value with the keys below.

key	Content
	Moves the blinking digit.
	Increases the blinking digit by 1.
	Sets (stores) the parameter.
	Switch the polarity(+/-).

\*Each time the SAMPLE key is pressed, “ - ” is turned on and off at the leftmost digit. When on, the value is negative.

- Example of changing setting

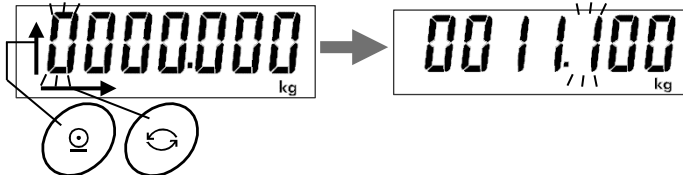

4. Press the **TARE** key to display **End**, HI is lit and the upper limit value blinks.
5. Change the upper limit value in the same way you adjusted the lower limit.
6. Press the **TARE** key to display **End** and return to the memory number display.
7. Press the **TARE** key to return to weighing mode after **End** is displayed. (Start comparing using the memory number displayed at this time.)

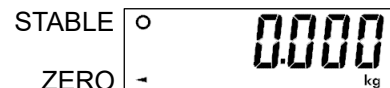
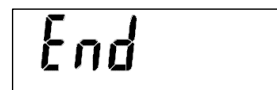
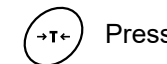
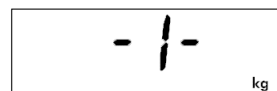
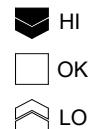
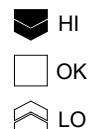
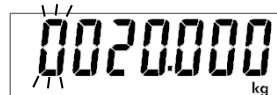
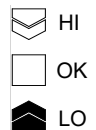
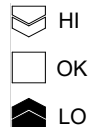
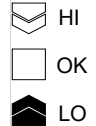
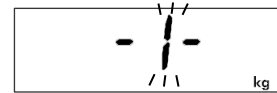



## 11. Display Hold Function

This function holds and displays the weighed value when it is in the set condition. lights up while the display is held.



### Display Hold Condition

The weighed value is held and displayed when it becomes stable outside the zero range (5d or more / -5d or less), or when the weighing value is outside the zero range (5d or more / -5d or less) and fluctuates within the "Display hold width" for 2 seconds.

### Cancel display hold condition

When the weighed value fluctuates from the value being held on the display by 10 times the "Display hold width" or reaches the zero range (between -4d and +4d), the display hold state is canceled when the "Hold release time" elapses.

- The "d" represents the minimum display.
- The "Display hold width" can be selected by the item  in "15.6 Parameter List"
- The "Hold release time" can be selected by the item  in "15.6 Parameter List"



## 12. Impact Shock Detection Function (ISD)

The FG-CWP/FG-ACWP series has a function to detect impact to the mass sensor section and to display the impact level. By lowering the impact level at the time of loading, it is possible not only to alleviate variation in the weighed value but also to reduce the risk of failure of the mass sensor section.

Impact level display is from level 0 to level 3, 4 level.

Impact level	Shock indicator	Contents
0	No	Safe
1	SHOCK 	Caution : Consider impact mitigation.
2	SHOCK 	Warning : Do not apply greater impact.
3	SHOCK 	Danger : Sensor may be damaged.

Refer to "15. Function Table" and set the internal setting to  to turn on the function of displaying the shock level.

- There is no buzzer sound or memory function upon detection.

### Note

- Impact on the weighing sensor may be applied to the weighing pan at time of loading, or it may be applied from the floor on which the scale is installed. The impact detection function also works for impact applied from the floor.



## 13. Auto-Tare Function

The FG-CWP/FG-ACWP series has an auto-tare function, used together with the comparator function, that enables masses within a certain range (OK) to be weighed in succession as the scale automatically tares. First place a container on the weighing pan. Press the **TARE** key to zero the display once the container is weighed. Gradually place or take away objects until the comparison result shows OK. When the result shows OK and the measurement stable time set for the function table item

**Rel-t** has elapsed, the scale will automatically tare the weighed value and return to zero, indicating it is ready for the next weighing. Repeat this process to compare weights.

- In order to use the auto-tare function, function tables must be configured as follows. (Refer to "15. Function Table")

Function table	Content
<b>[P-1]</b>	Compare regardless of stability of weighed value (other settings may be used depending on the application).
<b>Rel-1</b>	Enable auto-tare function.
<b>Rel-t 0~9</b>	Condition for taring automatically (Select according to the content and method of work in order to eliminate incorrect operations, such as instantly judging to be OK and starting taring even though actual mass is not OK, and to eliminate excessively long wait times.)

- Take-away check weighing **[P-P 1]**

This is a method of comparing against negative mass values. After a container with objects in it is placed on the weighing pan and tared, take objects away while staying in the OK range to compare masses.

The same operation is also possible in the ordinary method of comparing, but comparison results start from HI, changing from HI to OK to LO as more objects are taken away. With this setting, comparison results are shown in the order LO to OK to HI (negative comparison) as objects are taken away in order to make this easier to understand intuitively. Set to **[P-P 1]** along with **Rel-1** for the auto-tare function. In this setting, both positive and negative values can be set for LO and HI values, ignoring polarity. The comparison results are as shown in the table below.

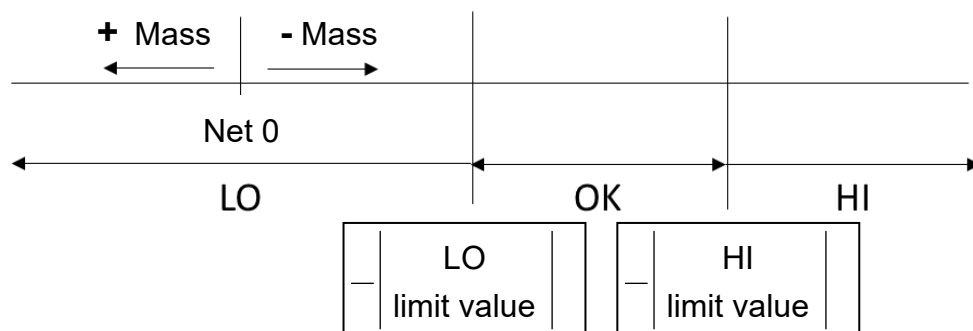

- When function table **Rel-F 1** (automatically tare initial load) is set.

To start the auto-tare function, a container filled with objects needs to be placed on the weighing pan and its weighed value tared using the **TARE** key. By setting **Rel-F 1**, the mass of the container placed on the scale after confirming zero is automatically tared. After weighing then removing everything placed on the weighing pan, the scale returns to the zero point and the tare weight is automatically cleared. If the scale does not return to the zero point, the tare weight can be cleared by setting it to zero with the **ZERO** key.



## 14. Sensitivity Adjustment

Sensitivity adjustment is a function that adjusts the scale so it shows the correct mass. Sensitivity adjustment should be performed in the following cases.

- When the scale is initially installed.
- When the scale is moved to a location far away.
- When the ambient environment has greatly changed.
- Periodically.

Note: Sensitivity adjustment can not be performed on the Legal for Trade models.



### 14.1. Sensitivity Adjustment Items

Sensitivity adjustment mode has the following three functions.

- Sensitivity adjustment using a weight
- Correcting for gravitational acceleration
- Restoring sensitivity adjustment value to factory default

There are two ways to enter sensitivity adjustment mode as shown below.

#### Method 1 (using operation keys)

1. Confirm that the scale is in weighing mode (display shows “kg” (“g”), “lb”, “oz” or “pcs”).
2. Press and hold the **TARE** key for 4 sec. or longer. Release the key when **CAL** is displayed. (Then go to “14.2. Sensitivity Adjustment Using a Weight”, “14.3. Correcting for Gravitational Acceleration” or “14.4. Restoring Sensitivity Adjustment Value to Factory Default”.)

Note: The above operation is disabled for the Legal for Trade models. The Legal for Trade models can not enter the calibration mode.

#### Method 2 (using the **CAL** switch)

1. Confirm that the scale is in weighing mode (display shows “kg” (“g”), “lb”, “oz”, or “pcs”).
2. Remove the four screws from the load cell/CAL cover on the rear of the display to remove the load cell/CAL cover.
  - When closing the load cell/CAL cover, tighten the four screws to maintain waterproof performance. (Recommended torque 0.4N · m)
3. Press the **CAL** switch to display **CAL**. (Then go to “14.2. Sensitivity Adjustment Using a Weight”, “14.3. Correcting for Gravitational Acceleration” or “14.4. Restoring Sensitivity Adjustment Value to Factory Default”.)

Note: The load cell / CAL Cover for the Legal for Trade models has been sealed using wire locked screws. The CAL switch does not work on the Legal for Trade models.

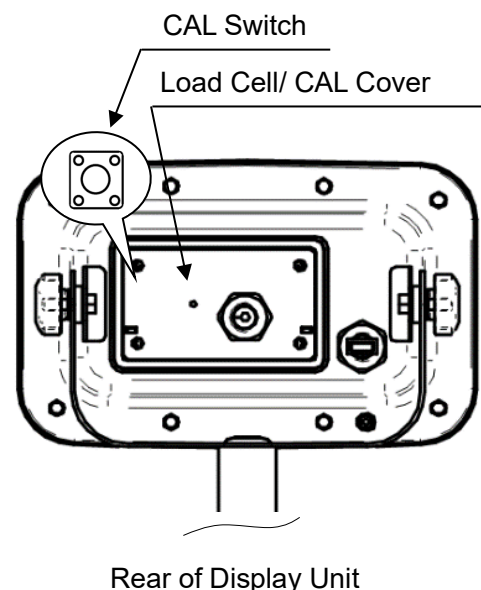

□ Relations between items in sensitivity adjustment mode and key operations are shown in the diagram below.

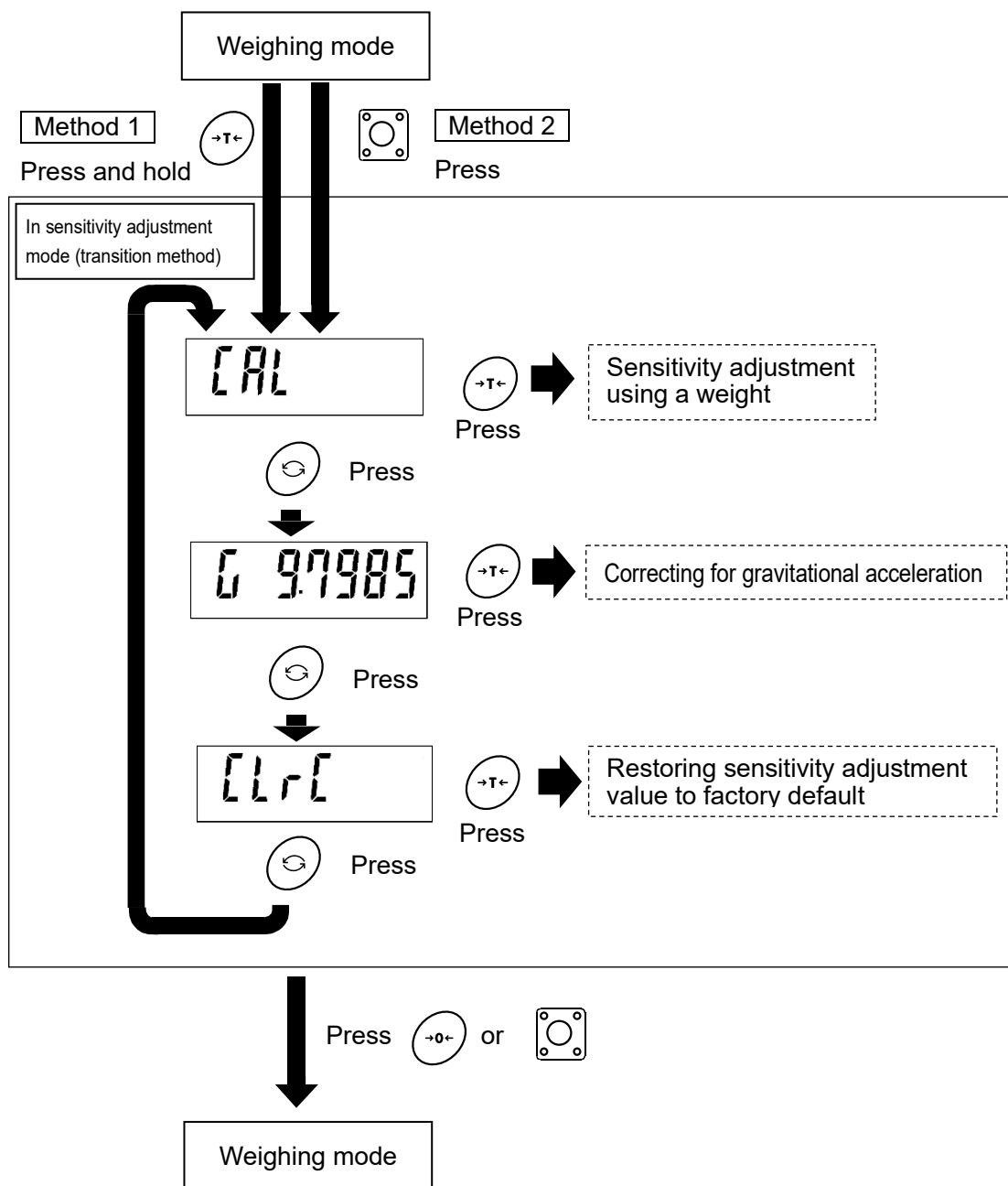

Note: Use the **MODE** key to select the item to execute, and then execute with the **TARE** key.

Note: To end sensitivity adjustment mode, press the **ZERO** key or **CAL** switch. This will return you to weighing mode.



## 14.2. Sensitivity Adjustment Using a Weight

Sensitivity adjustment must be done using a weight when the scale is used for the first time or when moving it to a different location. If you cannot obtain a sensitivity adjustment weight, the scale can be adjusted by correcting for gravitational acceleration. Refer to the gravitational acceleration map at the end of this document to change the gravitational acceleration value saved on the scale to that for the location where it is installed.

**Note: Prepare a weight. (A weight equivalent to the weighing capacity of the scale to be adjusted is recommended. However, the value for the weight can be set (changed).)**

1. Turn on the scale and supply it with power for 30 minutes or longer.

- Change the parameter for the function table item **POFF** or place something on the weighing pan to prevent the automatic power off function from activating.

Press

2. Refer to “14.1. Sensitivity Adjustment Items”. **CAL** is displayed when you enter sensitivity adjustment mode.

Press

3. Press the **TARE** key to display **CAL 0**. Make sure there is nothing on the weighing pan and wait for the stability indicator to light up.

4. Press the **TARE** key to save the zero point on the scale and display the value for the weight.

- The value for the weight is the same as the weighing capacity. (Initial state)
- When you enter with “kg” (“g”) or “pcs” mode, the value is in “kg”. With “lb” or “oz”, then “lb”.
- To adjust just the zero point, turn off the scale to end without performing step 5.

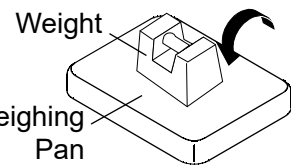

5. To adjust with a weight value different than the weighing capacity, change the value with the keys below.

Key	Content
	Moves the blinking digit
	Increases the blinking digit by 1

Press

- A weight equivalent to the weighing capacity of the scale is ordinarily used. If using a different weight, it should be at least 2/3 the weighing capacity.

6. Place a weight of the displayed value on the weighing pan. Wait for the stability indicator to light up.

7. Press the **TARE** key to end sensitivity adjustment. **End** will be displayed.

To end setting, press the **ZERO** key or **CAL** switch. This will return you to weighing mode.

8. Place a weight on the weighing pan again to check if it is within the set value  $\pm 0.01\text{g}$ (FG-30KCMWP/FG-30KACMWP) /  $\pm 0.02\text{g}$ (FG-60KCLWP/FG-60KACLWP) /  $\pm 0.04\text{g}$ (FG-150KCLWP/FG-150KACLWP). If it is not within the range, start over from the first step of this procedure in the appropriate ambient conditions.

**Note: If the scale is moved to a distant location after sensitivity adjustment, adjust the gravitational acceleration value to that of the area where it will be adjusted next. Then adjust the scale. See the next chapter for setting gravitational acceleration.**



## 14.3. Correcting for Gravitational Acceleration

**Note:** If sensitivity adjustment is done using a weight at the place where the scale is used, it does not need to be corrected for gravitational acceleration.

1. Refer to “14.1. Sensitivity Adjustment Items”. CAL is displayed when you enter sensitivity adjustment mode.

Press

2. Press the MODE key to display the gravitational acceleration parameter (ex. “G9.7985”).

3. Press the TARE key to enter gravitational acceleration setting mode.

Press

4. To change the gravitational acceleration parameter displayed, use the keys below.

Key	Content
	Moves the blinking digit
	Increases the blinking digit by 1

Press (select)

Press

5. Press the TARE key to display End and save the parameter.

6. To adjust using a weight, return to step 2 of “14.2. Sensitivity Adjustment Using a Weight”. To end setting, press the

ZERO key or CAL switch. This will return you to weighing mode.



## 14.4. Restoring Sensitivity Adjustment Value to Factory Default

To change sensitivity adjustment due to incorrect operation, etc., restore sensitivity adjustment by gravity acceleration or weight to factory default.

1. Refer to “14.1. Sensitivity Adjustment Items”. [CAL] is displayed when you enter sensitivity adjustment mode.

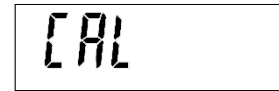

2. Press the [MODE] key two times to display [LrL].

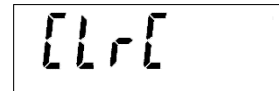
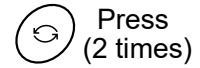

3. Press the [TARE] key to display [LrL na]. (“no” blinks)

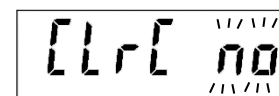

4. Press the [PRINT] key to switch to [LrL ga]. (“go” blinks)



- To cancel the operation, press the [ZERO] key. You will be returned to the status in step 2.

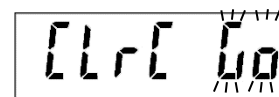

5. If [LrL ga] is displayed, press the [TARE] key to restore to factory default and display [End].

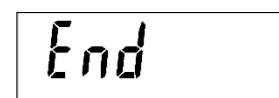

To end setting, press the [ZERO] key or [CAL] switch. This will return you to weighing mode.



## 15. Function Table

This is the function for viewing and changing items that determine the operation of the scale. Function table values are stored in non-volatile memory even when the display is turned off.

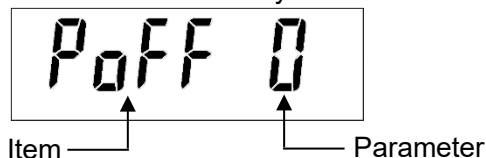

### 15.1. Parameter Setting Procedure

1. Use the **ON/OFF** key to turn off the scale.
2. Press the **ON/OFF** key while pressing the **TARE** key to display the software version **P-X.XX**.
3. After approx. 2 seconds, the class **Func** is displayed.
4. Press the **MODE** key to select the desired class.

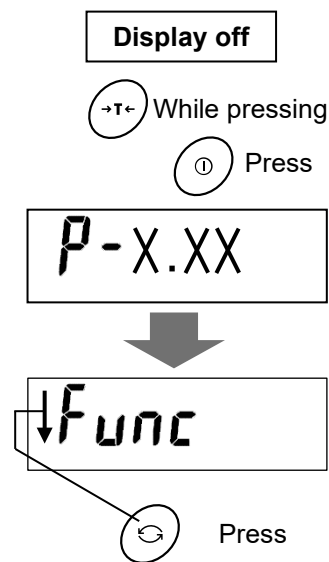

### 15.2. Func setting

Use the class **Func** to determine detailed functions for weighing, communication, etc.

1. Press the **MODE** key to display the class **Func**, and then press the **TARE** key.
2. The first item is displayed. Refer to the table below to change items or set details. See "15.6. Parameter list" for items.

Key	Content
	Moves to the next item.
	Increases the blinking digit by 1.
	Sets the parameter.

3. Press the **TARE** key to save the setting. **End** is displayed followed by the class **id**.
  - To exit without saving the setting, press the **ZERO** key. Class **id** is displayed.
4. Press the **ON/OFF** key to turn the display off.

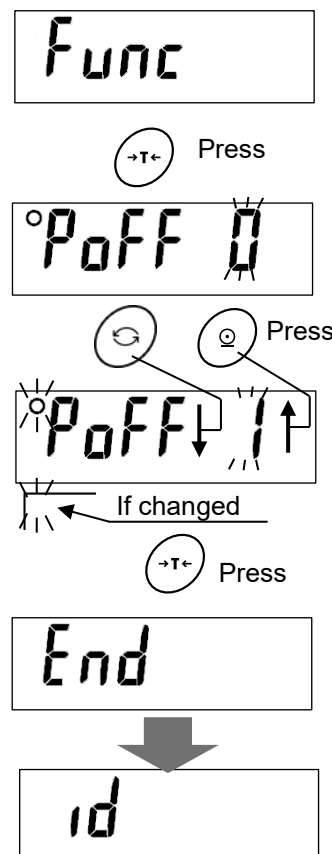



## 15.2.1. Setting Example

To set auto power-off function to “Enabled”, and the display resolution function to “1/3000”:

1. Display the class `Func` . See “[15.1. Parameter Setting Procedure](#)” .
2. Press the `TARE` key to display `PaFF 0`.
3. Press the `PRINT` key to display `PaFF 1` is displayed.
4. Press the `MODE` key several times until `rESo 1`.
5. Press the `PRINT` key several times until `rESo 0` is displayed.
6. Press the `TARE` key to save the setting `End` and is displayed followed by the class `id` .
  - To exit without saving the setting, press the `ZERO` key. `id` is displayed.
7. Press the `ON/OFF` key to turn the display off.

Func



Press

PaFF 0



Each pressing switches the parameter

PaFF 1



Press several times

rESo 1



Each pressing switches the parameter

rESo 0



Press

End



id



## 15.3. id setting

The class `id` is used to set the ID number required at GLP output. See “[18. ID Number and GMP, GLP](#)” for the detailed setting procedure.



## 15.4. PASSYd setting

The class `PASSYd` is used to set administrator mode. See “[19. Password Lock Function](#)” for the detailed setting procedure.



## 15.5. Restoring Function Tables to Factory Default

1. Turn off the display.
  2. Press the **ON/OFF** key while pressing the **TARE** key to turn on the scale. Keep pressing the **TARE** key to display **[LrF no]**. ("no" blinks)
  3. Press the **PRINT** key to switch to **[LrF Uo]**. ("Uo" blinks)
  4. If **[LrF Uo]** is displayed, press the **TARE** key to restore the function tables to factory default. **End** is shown and the display turns off automatically.
- To cancel the operation, press the **ZERO** key. The display turns off automatically.
  - In addition to the function tables, the unit mass of the counting function and the limit values of the comparator function are also restored to the factory default.

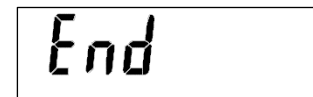
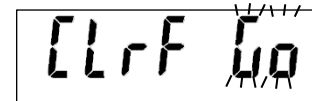
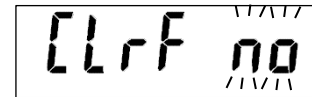



## 15.6. Parameter List

Class	Item	Parameter	Content/use
Func	Automatic power off function <input type="text" value="PaFF"/>	◆ 0	OFF
		1	ON (Turns off after 5 minutes)
		2	ON (Turns off after 10 minutes)
		3	ON (Turns off after 15 minutes)
		4	ON (Turns off after 30 minutes)
		5	ON (Turns off after 60 minutes)
	Automatic power on function <input type="text" value="P-on"/>	◆ 0	OFF
		1	ON (The scale turns on automatically if the power plug is connected.)
	Display resolution <input type="text" value="rESa"/> (See Note)	0	Low resolution (1/3,000)
		◆ 1	Normal resolution (1/6,000 to 1/7,500)
		2	High resolution (1/12,000 to 1/15,000)
		3	Max resolution (1/30,000)
	Zero tracking function <input type="text" value="trL"/>	0	OFF
		◆ 1	ON
	Stability band width <input type="text" value="St-b"/> (See Note)	◆ 0	±0.5d (width 1d)
		1	±1.0d (width 2d)
		2	±2.0d (width 4d)
	Stability band time <input type="text" value="St-t"/>	◆ 0	0.2 seconds
		1	0.5 seconds
		2	1.0 seconds
	Response <input type="text" value="Land"/>	0	Fast response / Poor vibration tolerance (for stable environments)
		1	↑↓
		◆ 2	↑↓
		3	↑↓
		4	Slow response/stabilized display (prioritizes stability)

◆: factory settings      d: readability (scale interval or "division")

**Automatic power off:** When the specified interval has passed while the display is zero, the display is stable and there is no key operation, the display turns off.

**Display resolution:** Changes the value for readability "d". (Resolution = Readability / Weighing capacity)

**Stability band width:** When the weighed value is within a certain width (stability band width) and a certain amount of time (stability band time) has passed, the scale judges that weighing is stable and lights up the stability indicator. To ensure maximum stability, set a large value. For faster judgment of stability at the expense of precision, use a smaller value.

**Stability band time:** When the weighed value is within a certain width (stability band width) and a certain amount of time (stability band time) has passed, the scale judges that weighing is stable and the stability indicator lights up. To ensure maximum stability, set a large value. For faster judgment of stability at the expense of precision, use a smaller value.

**Zero tracking:** A function that keeps the display at zero by tracking the zero point.

Class	Item	Parameter	Content/use
Func	Backlight control Lit	0	Always turned off
		1	Always lit
		2	Brightness decreases at 1 minutes after stabilizing
		3	Brightness decreases at 5 minutes after stabilizing
		4	Brightness decreases at 30 minutes after stabilizing
		◆ 5	Brightness decreases at 60 minutes after stabilizing
	Backlight and Comparator LED brightness Lit	0	Dark (40% brightness)
		◆ 1	↑↓ (60% brightness)
		2	↑↓ (80% brightness)
		3	Bright (100% brightness)
	Decimal point Pnt	◆ 0	Dot (.)
		1	Comma (,)
	GLP output Info	◆ 0	OFF
		1	ON (DATE and TIME : PC date and time)
		2	ON (DATE and TIME : blank (handwritten))
	Serial interface baud rate bPS	◆ 0	2400 bps
		1	4800 bps
		2	9600 bps
	Serial interface bit length, parity bitPr	◆ 0	7 bit / even parity
		1	7 bit / odd parity
		2	8 bit / non-parity
	Serial interface Output mode Prk	◆ 0	Key mode
		1	Auto print mode A (Reference=zero point)
		2	Auto print mode B (Reference=last stable value)
		3	Stream mode
		4	Key mode B (Immediately)
		5	Command mode only
		6	When comparator result is OK in Auto print mode A (Reference=zero point)
		7	When comparator result is OK in Auto print mode B (Reference=last stable value)
	Auto print polarity AP-P	◆ 0	Plus only
		1	Minus only
		2	Bipolarity
	Auto print difference AP-b	◆ 0	10 digit
1		100 digit	
ACK, error code ErrCd	◆ 0	No reply other than data at standard format/command	
	1	Reply to <AK>(ASCII : 06h) at standard format/command	
	2	Reply to echo back at standard format/command	
Serial interface channel selection SCH *1	◆ 0	USB selection	
	1	BLE options selection	

◆: factory settings      d: readability (scale interval or "division")

\*1 FG-CWP series (USB power model) only.

Class	Item	Parameter	Content/use
Func	Comparator comparison condition [P]	♦ 0	Comparator function suspended
		1	Compare all data
		2	Compare all stable data
		3	Compare data except that at -4d to +4d
		4	Compare stable data except that at -4d to +4d
		5	Compare all data at +5d and above
		6	Compare stable data at +5d and above
	Comparator ordinary comparison / Negative comparison [P-P] (See Note)	♦ 0	Ordinary comparison
		1	Negative comparison
	Comparator comparison results [P-r]	♦ 0	OFF
		1	ON
	Auto-tare function [At]	♦ 0	OFF
		1	ON
	Auto-tare condition [At-t]	0	0.0 seconds
		1	0.5 seconds
		♦ 2	1.0 seconds
		3	1.5 seconds
		4	2.0 seconds
		5	2.5 seconds
		6	3.0 seconds
		7	4.0 seconds
		8	5.0 seconds
		9	6.0 seconds
	Tare initial load [At-F]	♦ 0	OFF
		1	ON
	Display hold width [Hold]	♦ 0	Display hold function OFF
		1	Hold display only when stable
		2	±10d
		3	±20d
		4	±50d
		5	±100d

♦: factory settings      d: readability (scale interval or "division")

Class	Item	Parameter	Content/use
Func	Hold release time [Hd-t]	0	Release immediately.
		1	5 seconds
		◆ 2	10 seconds
		3	15 seconds
		4	20 seconds
		5	30 seconds
		6	1 minute
		7	2 minutes
		8	5 minutes
		9	10 minutes
	Impact Shock Detection [Isd]	0	OFF
		◆ 1	ON
Mobile battery [bAt] *1	◆ 0	OFF	
	1	Do not set this parameter.	
	2	ON	
id	ID number for GLP output [id]		ID number setting
PASSWD	Password lock function [LocL]	◆ 0	OFF
		1	ON
	2	ON + key restriction (Only [ZERO] and [TARE] keys can be operated during weighing)	
	Password registration [PASSno]		Administrator password input

◆: factory settings      d: readability (scale interval or "division")

\*1 FG-CWP series (USB power model) only.

**Password lock function:** This function requires the administrator password registered in "Password registration" in order to make changes to the function tables. If you do not require a password, changes that can be made to the function tables are limited.

**Password registration:** Enter the password required when using the "19. Password Lock Function". (Note: In some countries or areas, "[rE5a]", "[5t-b]" and "[LP-P]" are not available for the Legal for Trade models.)



## 16. Communication



### 16.1. USB Interface (FG-CWP series (USB power model) only )

Two-way communication can be performed via USB.

Use the cable extending from the rear of the display unit to connect to a PC.

See “16.2. Data Format” for the communication format.

A dedicated driver must be installed to enable communication between the scale and PC via USB interface. If the PC's OS is Windows, data communication software such as WinCT can be used to import weight data to the PC.

WinCT can be downloaded from the A&D website (<https://www.aandd.jp/>). See the WinCT instruction manual for details on how to install WinCT.

#### How to use

1. Connect it to your PC. The driver will be installed automatically. If the driver is not installed, please refer to "Details on how to use and examples " below and install the driver.
2. Confirm the COM port number.
3. Configure port settings and communication settings for the data communication software (WinCT's RsCom, etc.).
4. Connect the PC and scale via the USB cable.
5. (Example) Press the scale's PRINT key to enable the PC to receive weighed values.

#### Details on how to use and examples

- Installing the USB driver (set on PC as COM port)
  1. Download the USB driver software from the A&D website.  
Open the A&D website at the URL (<https://www.aandd.jp/>) and open the "Support" and "Software" pages in that order.  
Download the driver software from "download" of "Virtual COM mode driver software for the FG-CWP series USB interface".  
Note : The location and version of the software may be changed without notice.
  2. Double click the downloaded driver (balance\_usb\_driver.zip) to expand it and create the folder “balance\_usb\_driver”.
  3. Double click “CDM21224\_setup.exe” in the folder to start installation.
  4. Follow the on-screen instructions to complete installation.

#### Confirming the COM port number (confirming that USB driver installation is complete)

1. On the PC, click the “Start” button and select “Control Panel”.
2. Select “Hardware and Sound” then “Device Manager”, and then confirm the COM port number in the “Ports (COM & LPT)” item. It is displayed as “USB Serial Port (COM\*)”.

The COM port number is “9” in the example in the diagram below.

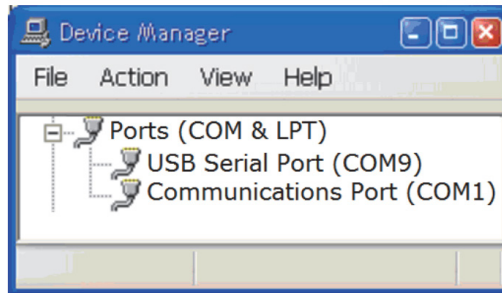

**⚠ Note:** The number for the COM port added may differ depending on the hardware of the PC.  
Confirm the COM port number in Device Manager.

**Communication software**

An application software will be needed for communication.  
WinCT is used here as an example.

1. Start RsCOM of WinCT.
2. Change the “Port:Com” setting to the number for the COM port added.

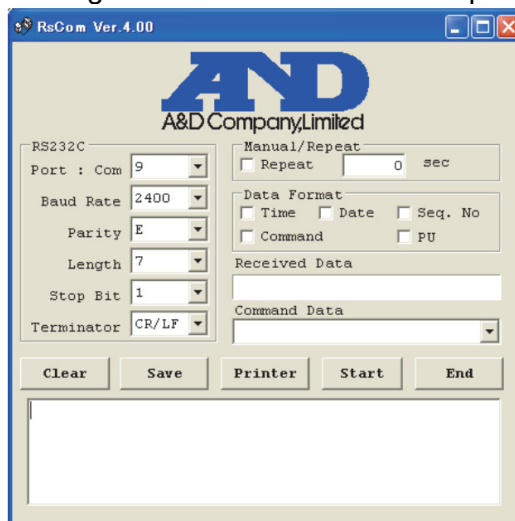

**Starting data communication**

1. Connect the PC and scale via the USB cable.
2. Turn on the scale and enter weighing mode.
3. Click the Start button of RsCOM of WinCT. Transmission and receiving of data is enabled.
4. Press the scale's PRINT key to output weighed values from the scale and receive them via RsCom.

Note: The method for outputting weighed values can be changed in the scale’s function tables.

Transmission form	Bidirectional USB virtual COM
Data format	Baud rate 2400, 4800, 9600bps
	Data bits 7 bits + parity 1 bit (even or odd) or 8 bits (non parity)
	Start bit 1 bit
	Stop bit 1 bit
	Code ASCII



## 16.2. Data Format

- When function table  $[P-r 0]$

S	T	,	+	0	0	0	0	0	.	0	0	_	k	g	C <sub>R</sub>	L <sub>F</sub>
---	---	---	---	---	---	---	---	---	---	---	---	---	---	---	----------------	----------------

- When function table  $[P-r i]$

S	T	,	O	K	,	+	0	0	0	0	0	.	0	0	_	k	g	C <sub>R</sub>	L <sub>F</sub>
---	---	---	---	---	---	---	---	---	---	---	---	---	---	---	---	---	---	----------------	----------------

Header      Comparison results      Data      Unit Terminator  
 (“\_” indicates a space)

- There are four types of headers, as shown below.
  - ST: Data is stable in mass measurement
  - QT: Data is stable in counting mode
  - US: Data is not stable (including in counting mode)
  - OL: Data is out of weighing range
- There are three types of Comparison results, as shown below.
  - HI : When the weighed value is high
  - OK : When the weighed value is OK
  - LO : When the weighed value is low
  - : When not comparing
- The data consists of nine characters including the polarity and decimal point.
- There are three types of units, as shown below.
  - \_ k g :Mass data “kg”
  - \_ \_ g :Mass data “g”
  - \_ P C :Counting data “pcs”
- As a terminator, C<sub>R</sub>L<sub>F</sub> is always output. CR : 0Dh, LF : 0Ah
- Output data example

Weighing data “kg” (+)      

S	T	,	+	0	0	1	2	3	.	4	5	_	k	g	C <sub>R</sub>	L <sub>F</sub>
---	---	---	---	---	---	---	---	---	---	---	---	---	---	---	----------------	----------------

Weighing data “g” (-)      

S	T	,	-	0	0	0	0	1	2	3	4	_	_	g	C <sub>R</sub>	L <sub>F</sub>
---	---	---	---	---	---	---	---	---	---	---	---	---	---	---	----------------	----------------

Counting data “pcs” (+)      

Q	T	,	+	0	0	0	1	2	3	4	5	_	P	C	C <sub>R</sub>	L <sub>F</sub>
---	---	---	---	---	---	---	---	---	---	---	---	---	---	---	----------------	----------------

Data unstable “kg” (+)      

U	S	,	+	0	0	1	2	3	.	4	5	_	k	g	C <sub>R</sub>	L <sub>F</sub>
---	---	---	---	---	---	---	---	---	---	---	---	---	---	---	----------------	----------------

Mass out of weighing range “kg” (+)      

O	L	,	+	9	9	9	9	9	.	9	9	_	k	g	C <sub>R</sub>	L <sub>F</sub>
---	---	---	---	---	---	---	---	---	---	---	---	---	---	---	----------------	----------------

Comparison results HI “kg” (+)      

S	T	,	H	I	,	+	0	0	1	2	3	.	4	5	_	k	g	C <sub>R</sub>	L <sub>F</sub>
---	---	---	---	---	---	---	---	---	---	---	---	---	---	---	---	---	---	----------------	----------------

Comparison results OK “g” (+)      

S	T	,	O	K	,	+	0	0	0	1	2	3	4	5	_	_	g	C <sub>R</sub>	L <sub>F</sub>
---	---	---	---	---	---	---	---	---	---	---	---	---	---	---	---	---	---	----------------	----------------

Comparison results LO “kg” (+)      

S	T	,	L	O	,	+	0	0	0	0	1	.	2	3	_	k	g	C <sub>R</sub>	L <sub>F</sub>
---	---	---	---	---	---	---	---	---	---	---	---	---	---	---	---	---	---	----------------	----------------

Comparison results -- “kg” (+)      

S	T	,	-	-	,	+	0	0	1	2	3	.	4	5	_	k	g	C <sub>R</sub>	L <sub>F</sub>
---	---	---	---	---	---	---	---	---	---	---	---	---	---	---	---	---	---	----------------	----------------

## Data output mode

### □ Key mode (default)

Set to function table  Prt 0.

If the  PRINT key is pressed when the stable value mark is displayed, the weighed value will be output once. At that time, the displayed weighed value will blink once to indicate that it has been output.

### □ Auto print A mode

Set to function table  Prt 1.

When the weighed value exceeds the range specified by  RP-P (auto print polarity) and  RP-b (auto print width) from the standard "zero display", and the stable value mark is on, the weighed value will be output once. Also, if the  PRINT key is pressed while the stable value mark is on, the weighed value will be output once.

### □ Auto print B mode

Set to function table  Prt 2.

When the weighed value exceeds the range specified by  RP-P (auto print polarity) and  RP-b (auto print width) from the standard "value previously displayed with a stable value mark", and the stable value mark is on, the weighed value will be output once. Also, if the  PRINT key is pressed while the stable value mark is on, the weighed value will be output once. At that time, the displayed weighed value will blink once to indicate that it has been output.

### □ Stream mode

Set to function table  Prt 3.

Regardless of the presence or absence of the stable value mark, weighed value will be output.

### □ Key mode B

Set to function table  Prt 4.

Regardless of the presence or absence of the stable value mark, when the PRINT key is pressed, the weighed value will be output once.

At that time, the displayed weighed value will blink once to indicate that it has been output

### □ Auto print A mode and OK

Set to function table  Prt 5.

When the weighed value exceeds the range specified by the  RP-P (auto print polarity) and the  RP-b (auto print width) from the standard "zero display", and the comparator result is OK and the stable value mark is on, the weighed value will be output once. Also, if the  PRINT key is pressed while the stable value mark is on, the weighed value will be output once.

### □ Auto print B mode and OK

Set to function table  Prt 7.

When the weighed value exceeds the range specified by the  RP-P (auto print polarity) and the  RP-b (auto print width) from the standard "value previously displayed with a stable value mark", the comparator result is OK and the stable value mark is on, the weighed value will be output once. Also, if the  PRINT key is pressed while the stable value mark is on, the weighed value will be output once. At that time, the displayed weighed value will blink once to indicate that it has been output.

## Baud rate

Select the baud rate according to the device to be connected.

- 2400 bps (  )
- 4800 bps (  )
- 9600 bps (  )

## Command mode

In command mode, the scale is controlled by commands from an external device such as a computer.

- Always valid regardless of the setting of the .

## Commands list

Command	Function	Remarks
Q	Requests data be output immediately.	
Z	Zeros the scale when the weighed value is stable.	Same operation as the <input type="text" value="ZERO"/> key
T	Tares the scale when the weighed value is stable.	Same operation as the <input type="text" value="TARE"/> key
U	Switches the weighing unit.	Same operation as the <input type="text" value="MODE"/> key
ID	Sets the ID number.	
?ID	Requests the ID number.	
HI	Set the HI limit for the memory number in use.	
LO	Set the LO limit for the memory number in use.	
CN	Set Comparator memory (switching the memory in use).	
?HI	Outputs the HI limit value for the memory number in use..	
?LO	Outputs the LO limit value for the memory number in use..	
?CN	Comparator memory recall (recalling the memory in use).	

## Command example (“\_” indicates a space (20h))

- To request data be output immediately

Command

Response

S	T	,	+	0	0	1	2	3	.	4	5	_	k	g	<input type="text" value="CR"/>	<input type="text" value="LF"/>	Stable positive data
U	S	,	+	0	0	1	2	3	.	4	5	_	k	g	<input type="text" value="CR"/>	<input type="text" value="LF"/>	Unstable positive data
O	L	,	+	0	0	1	2	3	.	4	5	_	k	g	<input type="text" value="CR"/>	<input type="text" value="LF"/>	When “E” is displayed

The response of the command can be switched by the function table .  
(No response when set to function table . The invalid command is ignored.)

The following is an example for function table  (<AK> Response).  
<AK> : ASCII 06h

- To zero the weighed value when it is stable (no response if )

Command

Response    When zeroing operation is possible

- To tare the weighed value when weighed value is stable (no response if )

Command

Response 

<AK>	C <sub>R</sub>	L <sub>F</sub>
------	----------------	----------------

 When zeroing operation is possible

- To switch the weighing unit (no response if 

E <sub>r</sub>	L <sub>d</sub>	0
----------------	----------------	---

)

Command 

U	C <sub>R</sub>	L <sub>F</sub>
---	----------------	----------------

Response 

<AK>	C <sub>R</sub>	L <sub>F</sub>
------	----------------	----------------

 When zeroing operation is possible

- To set the ID number (no response if 

E <sub>r</sub>	L <sub>d</sub>	0
----------------	----------------	---

)

Command 

I	D	:	0	0	0	1	0	0	C <sub>R</sub>	L <sub>F</sub>
---	---	---	---	---	---	---	---	---	----------------	----------------

Response 

<AK>	C <sub>R</sub>	L <sub>F</sub>
------	----------------	----------------

- To request the ID number

Command 

?	I	D	C <sub>R</sub>	L <sub>F</sub>
---	---	---	----------------	----------------

Response 

I	D	,	0	0	0	1	0	0	C <sub>R</sub>	L <sub>F</sub>
---	---	---	---	---	---	---	---	---	----------------	----------------

- To set the HI limit value (no response if 

E <sub>r</sub>	L <sub>d</sub>	0
----------------	----------------	---

)

Sends a six-digit number that does not contain "+/-" or decimal point

Command 

H	I	:	+	0	0	0	5	0	0	C <sub>R</sub>	L <sub>F</sub>
---	---	---	---	---	---	---	---	---	---	----------------	----------------

Response 

<AK>	C <sub>R</sub>	L <sub>F</sub>
------	----------------	----------------

- To set the LO limit value (no response if 

E <sub>r</sub>	L <sub>d</sub>	0
----------------	----------------	---

)

Sends a six-digit number that does not contain "+/-" or decimal point

Command 

L	O	:	+	0	0	0	2	0	0	C <sub>R</sub>	L <sub>F</sub>
---	---	---	---	---	---	---	---	---	---	----------------	----------------

Response 

<AK>	C <sub>R</sub>	L <sub>F</sub>
------	----------------	----------------

- To set the comparator memory (no response if 

E <sub>r</sub>	L <sub>d</sub>	0
----------------	----------------	---

)

Command 

C	N	:	X	X	C <sub>R</sub>	L <sub>F</sub>
---	---	---	---	---	----------------	----------------

 XX is memory number (00~09)

Response 

<AK>	C <sub>R</sub>	L <sub>F</sub>
------	----------------	----------------

- To output the HI limit value

Command 

?	H	I	C <sub>R</sub>	L <sub>F</sub>
---	---	---	----------------	----------------

Response 

H	I	,	+	0	0	0	5	0	0	C <sub>R</sub>	L <sub>F</sub>
---	---	---	---	---	---	---	---	---	---	----------------	----------------

- To output the LO limit value

Command 

?	L	O	C <sub>R</sub>	L <sub>F</sub>
---	---	---	----------------	----------------

Response 

L	O	,	+	0	0	0	2	0	0	C <sub>R</sub>	L <sub>F</sub>
---	---	---	---	---	---	---	---	---	---	----------------	----------------

- To recall the comparator memory

Command 

?	C	N
---	---	---

Response 

C	N	,	X	X	C <sub>R</sub>	L <sub>F</sub>
---	---	---	---	---	----------------	----------------

 XX is memory number (00~09)

- If the command cannot be executed or the received command cannot be processed, the following error code will be returned.

Error code	Description and how to resolve
EC,E00	<b>Communications error</b> A protocol error occurred in communications. Check the format and the baud rate.
EC,E01	<b>Undefined command error</b> An undefined command was received. Check the command.
EC,E02	<b>Not ready</b> The command received cannot be processed. e.g. The scale received a Q command, which requested the weighing data, but it was not in weighing mode with the display on. e.g. The scale received a Q command while processing a RE-ZERO command. Adjust the timing of transmitting the command.
EC,E06	<b>Format error</b> The format of the received command is incorrect. e.g. The data is numerically incorrect. e.g. Alphabet characters are input instead of values. Check the command.
EC,E07	<b>Setting value error</b> The received data exceeds the range of values that the scale can accept. Check the parameter values range of the command.

The following is an example for function table  $\boxed{\text{ErEd 2}}$  (Echo Back Response).

- To zero the weighed value when it is stable (no response if  $\boxed{\text{ErEd 0}}$ )

Command  $\boxed{Z} \boxed{C_R} \boxed{L_F}$

Response  $\boxed{Z} \boxed{C_R} \boxed{L_F}$  When zeroing operation is possible

- To tare the weighed value when it is stable (no response if  $\boxed{\text{ErEd 0}}$ )

Command  $\boxed{T} \boxed{C_R} \boxed{L_F}$

Response  $\boxed{T} \boxed{C_R} \boxed{L_F}$  When zeroing operation is possible

- To switch the weighing unit (no response if  $\boxed{\text{ErEd 0}}$ )

Command  $\boxed{U} \boxed{C_R} \boxed{L_F}$

Response  $\boxed{U} \boxed{C_R} \boxed{L_F}$  When zeroing operation is possible

- To set the ID number (no response if  $\boxed{\text{ErEd 0}}$ )

Command  $\boxed{I} \boxed{D} \boxed{:} \boxed{0} \boxed{0} \boxed{0} \boxed{1} \boxed{0} \boxed{0} \boxed{C_R} \boxed{L_F}$

Response  $\boxed{I} \boxed{D} \boxed{:} \boxed{0} \boxed{0} \boxed{0} \boxed{1} \boxed{0} \boxed{0} \boxed{C_R} \boxed{L_F}$

- To request the ID number

Command  $\boxed{?} \boxed{I} \boxed{D} \boxed{C_R} \boxed{L_F}$

Response  $\boxed{I} \boxed{D} \boxed{,} \boxed{0} \boxed{0} \boxed{0} \boxed{1} \boxed{0} \boxed{0} \boxed{C_R} \boxed{L_F}$

- To set the HI limit value (no response if  $\overline{Errd0}$ )  
 Sends a six-digit number that does not contain "+/-" or decimal point  
 Command 

H	I	:	+	0	0	0	5	0	0	C <sub>R</sub>	L <sub>F</sub>
---	---	---	---	---	---	---	---	---	---	----------------	----------------

  
 Response 

H	I	:	+	0	0	0	5	0	0	C <sub>R</sub>	L <sub>F</sub>
---	---	---	---	---	---	---	---	---	---	----------------	----------------
- To set the LO limit value (no response if  $\overline{Errd0}$ )  
 Sends a six-digit number that does not contain "+/-" or decimal point  
 Command 

L	O	:	+	0	0	0	2	0	0	C <sub>R</sub>	L <sub>F</sub>
---	---	---	---	---	---	---	---	---	---	----------------	----------------

  
 Response 

L	O	:	+	0	0	0	2	0	0	C <sub>R</sub>	L <sub>F</sub>
---	---	---	---	---	---	---	---	---	---	----------------	----------------
- To set the comparator memory (no response if  $\overline{Errd0}$ )  
 Command 

C	N	:	X	X	C <sub>R</sub>	L <sub>F</sub>
---	---	---	---	---	----------------	----------------

 XX is memory number (00~09)  
 Response 

C	N	:	X	X	C <sub>R</sub>	L <sub>F</sub>
---	---	---	---	---	----------------	----------------
- To output the HI limit value  
 Command 

?	H	I	C <sub>R</sub>	L <sub>F</sub>
---	---	---	----------------	----------------

  
 Response 

H	I	,	+	0	0	0	5	0	0	C <sub>R</sub>	L <sub>F</sub>
---	---	---	---	---	---	---	---	---	---	----------------	----------------
- To output the LO limit value  
 Command 

?	L	O	C <sub>R</sub>	L <sub>F</sub>
---	---	---	----------------	----------------

  
 Response 

L	O	,	+	0	0	0	2	0	0	C <sub>R</sub>	L <sub>F</sub>
---	---	---	---	---	---	---	---	---	---	----------------	----------------
- To recall the comparator memory  
 Command 

?	C	N
---	---	---

  
 Response 

C	N	,	X	X	C <sub>R</sub>	L <sub>F</sub>
---	---	---	---	---	----------------	----------------

 XX is memory number (00~09)
- The scale is not in a state where a command could be executed.  
 Then, the scale will reply "I".  
 Command 

Z	C <sub>R</sub>	L <sub>F</sub>
---	----------------	----------------

  
 Response 

I	C <sub>R</sub>	L <sub>F</sub>
---	----------------	----------------

 The scale is not in a condition that zero operation is possible.
- Command does not exist for the scale. Then, the scale will reply "?".  
 Command 

B	C <sub>R</sub>	L <sub>F</sub>
---	----------------	----------------

  
 Response 

?	C <sub>R</sub>	L <sub>F</sub>
---	----------------	----------------

 The scale received an undefined command.



## 17. Options



### 17.1. Option List

Option name	Contents
FG-27CWP (See Note)	Bluetooth communication interface
AD-8541-PC	Bluetooth dongle for PC connection
AD-8931	Bluetooth External Display
AX-TB301 (FG-CWP series (USB power model) only.)	AC adapter

See the optional instruction manual for details.

Note: For the Legal for Trade models, the Load Cell / CAL Cover is sealed, so the FG-27CWP cannot be installed, removed, or the DIP switch settings changed.



## 18. ID Number and GMP, GLP

The ID number is used to identify the scale when Good Manufacturing Practice (GMP) or Good Laboratory Practice (GLP) is used. Using the USB cable or optional FG-27CWP Bluetooth communication interface, the data corresponding to the following GMP or GLP can be output to a printer or PC.

- Results of calibration (“Calibration Report”)
- Results of calibration test (“Calibration Test Report”)
- “Start Block” and “End Block” for GMP, GLP data



### 18.1. ID Number Setting Procedure

- With the display turned off, while pressing and holding the **TARE** key, press the **ON/OFF** key to turn the display on and display the class **Func**. Use the **MODE** key to select the class **id**, and then press the **TARE** key.

- Refer to the table below to change items or set details.

Key	Content
	Moves to the next item.
	Increases the blinking digit by 1.
	Sets the parameter.

- Press the **TARE** key to store the setting. **PASSYd** appears after **End**.

- To cancel the restoring procedure, press the **ZERO** key.

- Press the **ON/OFF** key to turn the display off.

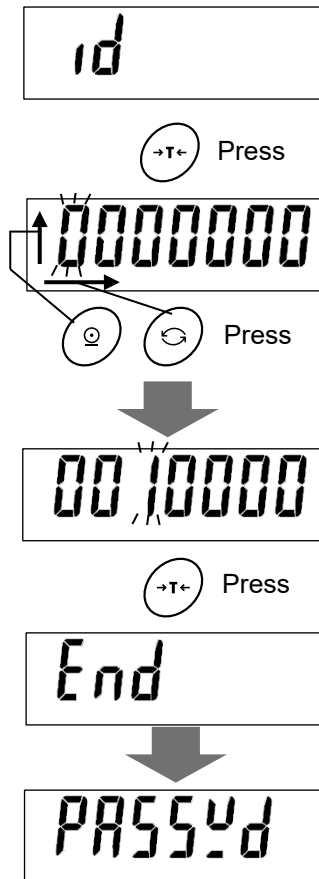

Display Character Table

0	1	2	3	4	5	6	7	8	9	-	_	A	B	C	D	E	F	G	H	I	J	K	L	M	N	O	P	Q	R	S	T	U	V	W	X	Y	Z
0	1	2	3	4	5	6	7	8	9	-	_	A	b	c	d	e	f	g	h	i	j	k	l	m	n	o	p	q	r	s	t	u	v	w	x	y	z

“\_” : Space, ASCII 20h



## 18.2. GMP, GLP Report

- To output the GMP, GLP report to a personal computer, select the function setting info 2
  - info 1 : DATE and TIME are PC date and time
  - info 2 : DATE and TIME are blank (handwritten)

### • Sensitivity adjustment Report

1. Perform sensitivity adjustment according to “14.2. Sensitivity Adjustment Using a Weight”.
2. End appears when calibration is complete.
3. GMP appears and the calibration report is output.
4. CAL appears again. Remove the weight. Press the ON/OFF key to turn the display OFF or press the CAL switch.

End

°GMP



To output the results

End

CAL

Format info 1

```

.....A&D<CRLF>
MODEL___FG-30KCM<CRLF>
S/N_____6A6123456<CRLF>
ID_____ABCDEFG<CRLF>
2022-04-01<CRLF>
<CRLF>
16:47:39<CRLF>
<CRLF>
ADJUSTED(EXT.)<CRLF>
CAL.WEIGHT<CRLF>
.....+30.000 kg<CRLF>
SIGNATURE<CRLF>
<CRLF>
<CRLF>
-----<CRLF>
<CRLF>
<CRLF>

```

← Manufacturer →

← Model →

← Serial number →

← ID number →

← Date →

← Time →

← Sensitivity adjustment →

← Weight value →

← Column for signature →

Format info 2

```

.....A&D<CRLF>
MODEL___FG-30KCM<CRLF>
S/N_____6A6123456<CRLF>
ID_____ABCDEFG<CRLF>
DATE<CRLF>
<CRLF>
TIME<CRLF>
<CRLF>
ADJUSTED(EXT.)<CRLF>
CAL.WEIGHT<CRLF>
.....+30.000 kg<CRLF>
SIGNATURE<CRLF>
<CRLF>
<CRLF>
-----<CRLF>
<CRLF>
<CRLF>

```

- ␣ : Space, ASCII 20h
- C<sub>R</sub> : Carriage return, ASCII 0Dh
- L<sub>F</sub> : Line feed, ASCII 0Ah

## • Calibration Test Report



Calibration test mode is used to compare a calibration weight with the calibration test data weighed by the scale.

□ This test does not perform sensitivity adjustment.

1. In weighing mode, press and hold the **CAL** switch until **[[** appears, and then release the switch, or, press and hold the **TARE** key for five seconds until **[[** appears and release the key.

□ Calibration test mode is not available when the function setting **infa 0** is selected.

2. Press the **TARE** key to display **[[ 0**.
3. Change the weight value if necessary. To change the weight value, press the **MODE** key. Change the value using the following keys.

Keys	Content
	Moves to the next item.
	Increases the blinking digit by 1.
	Sets the parameter.

4. With nothing on the weighing pan, press the **TARE** key. The zero point is measured and the weighed value is displayed in "kg" for a few seconds. Then, the value of the weight is displayed.
5. Place a weight of the displayed value on the weighing pan and press the **TARE** key to measure it. The weight value is displayed in kg for a few seconds.

6. **End** appears.

7. **CRP** appears and the calibration test report is output.

8. **[[** appears again. Remove the weight. Press the **ON/OFF** key to turn the display OFF or press the **CAL** switch.  
Format **infa i**

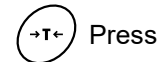
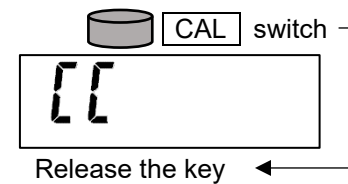

Change the weight value if necessary

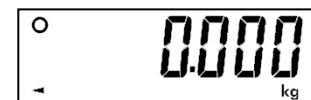

Weighing unit

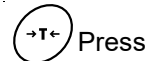
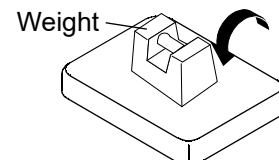

Weighing unit

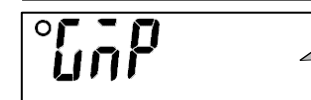
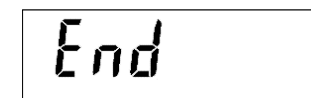

To output the results

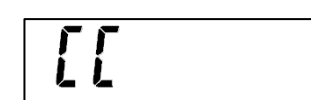
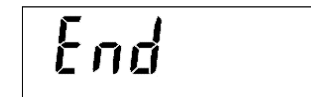

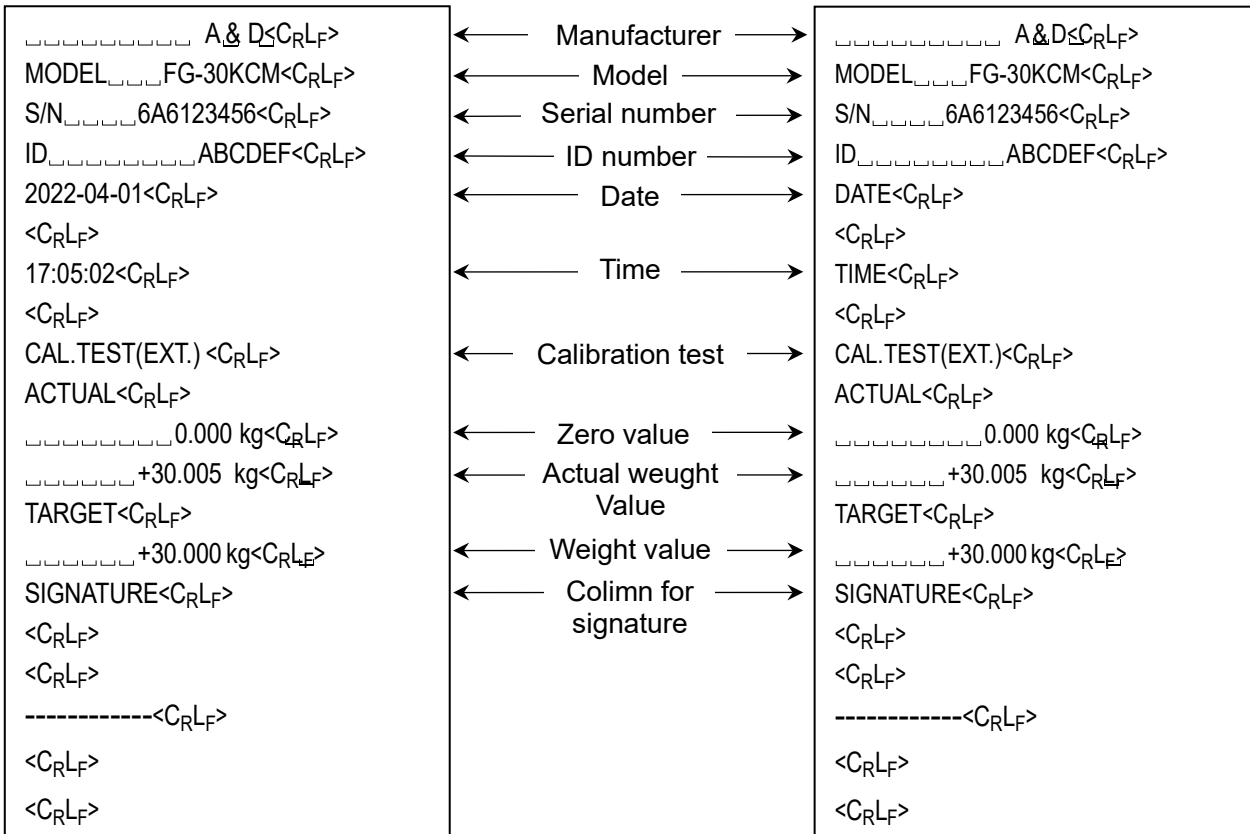

□ : Space, ASCII 20h  
 C<sub>R</sub> : Carriage return, ASCII 0Dh  
 L<sub>F</sub> : Line feed, ASCII 0Ah

• **Output of “Title block” and “End block”**

When weighed values are recorded as the GMP, GLP report, “Title Block” and “End Block” are added at the beginning and at the end of the group.

• **Title Block**

1. In weighing mode, press and hold the **PRINT** key until **Start** appears, and then release the key. The scale outputs the “Title Block.” The scale automatically returns to weighing mode.
2. Press the **PRINT** key or select auto-print mode to output the weighed values.

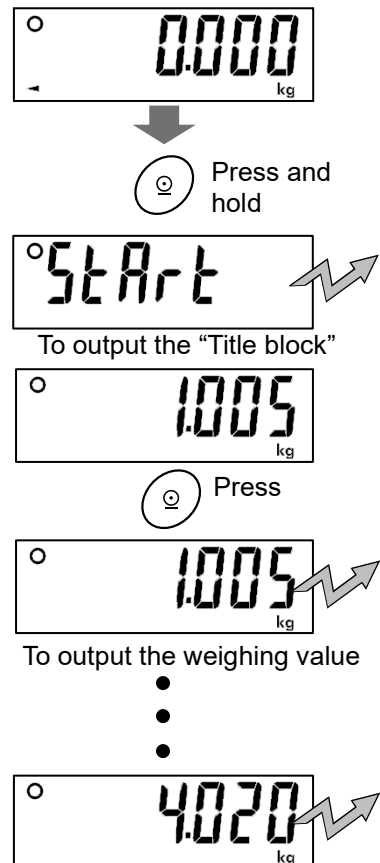

### End Block

3. Press and hold the **PRINT** key until `rEcEnd` appears, and then release the key. The scale outputs the "End Block."

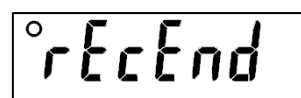
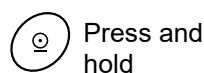

To output the "End block"

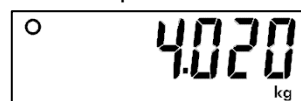

4. The scale automatically returns to weighing mode.

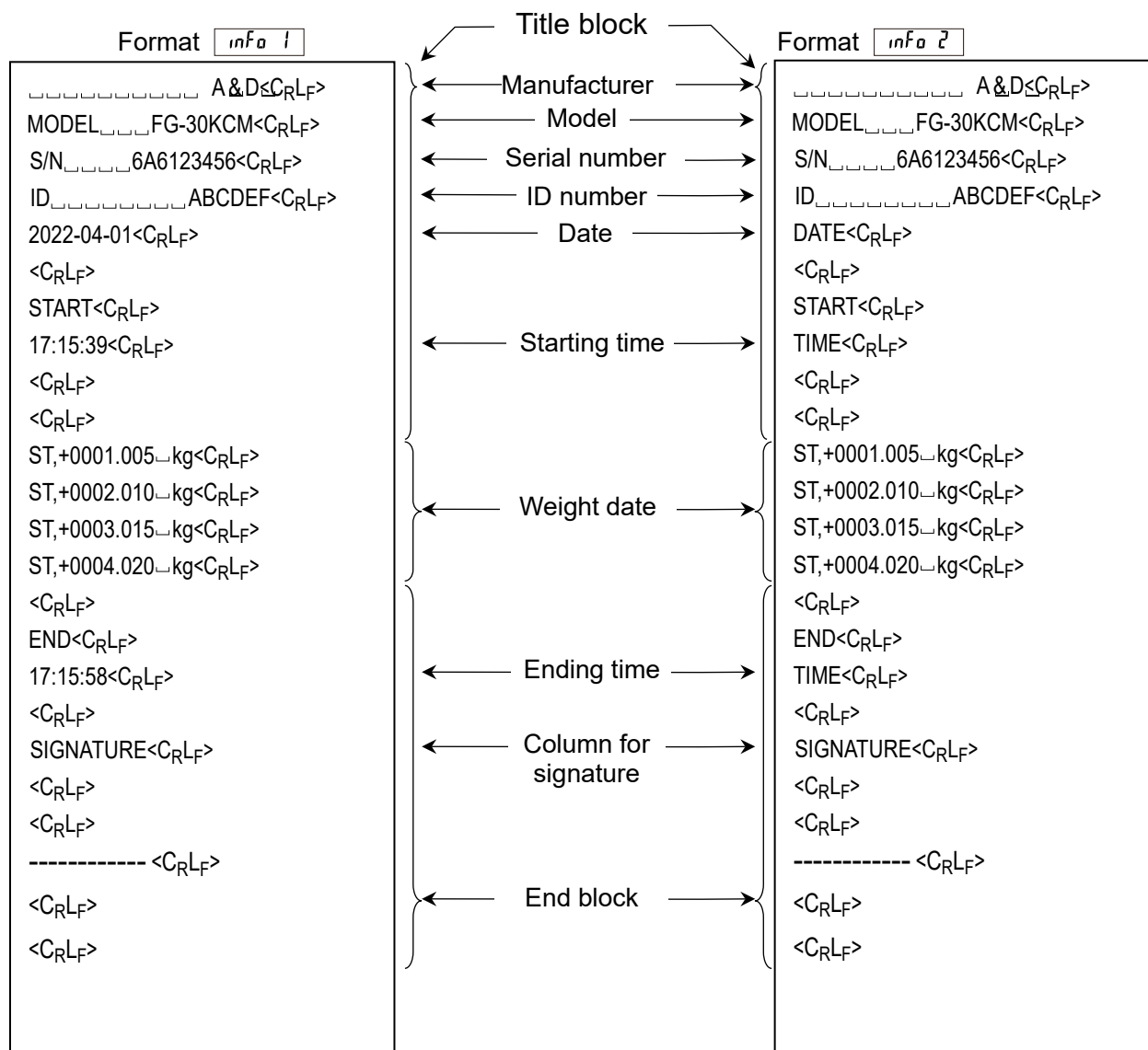

□ : Space ASCII 20h  
 C<sub>R</sub> : Carriage return, ASCII 0Dh  
 L<sub>F</sub> : Line feed, ASCII 0Ah



## 19. Password Lock Function

The passcode lock function is a feature that allows you to limit changes to the function table of the scale.

In the factory default setting, the password lock function is disabled.

To enable/disable the password lock function and to register the password, refer to the class `PASSYd` in "15.6. Parameter List". Set the password according to the table below. For `GUEST`, see "19.2. To Changing the Function Table After Setting `LocL 1` or `2`".

Funtion table	Value	Content
<code>LocL</code>	0	No password lock.
	1	Password lock is available.
	2	Password lock is available with key restrictions (Only the <code>ZERO</code> and <code>TARE</code> keys can be operated during weighing.)
<code>PASSno</code>		Register a password.



### 19.1. Setting Procedure

- With the display turned off, while pressing and holding the `TARE` key, press the `ON/OFF` key to turn the display on and display the class `Func`. Press the `MODE` key to select the class `PASSYd`, and then press the `TARE` key.

Keys	Content
	Moves to the next item.
	Increases the blinking digit by 1.
	Sets the parameter.

- `PASSYd` appears. Refer to the table above to change items or setting details.
  - To change the password only, select the setting item `PASSno` with the `MODE` key.
- Press the `TARE` key to store the setting. `PASSno` appears after `End`.
- After about 2 seconds, the password input screen will appear. Refer to the table above to set the password and press the `TARE` key to appear the class `Func` after `End`.
  - To cancel the restoring procedure, press the `ZERO` key.
- Press the `ON/OFF` key to turn the display off.

`PASSYd`

Press

`LocL 0`

Press

`LocL 1`

If changed

Press

`PASSno`

`10000`

Press

`1000`

Press

`End`



`Func`



## 19.2. To Changing the Function Table After setting *Loc 1* or *2*

With the display turned off, while pressing and holding the **TARE** key, press the **ON/OFF** key to turn the display on and display the software version **P-X.XX**. After viewing the software version **P-X.XX**, choose between **Adn in** and **Guest**. See the table below for the difference between **Adn in** and **Guest**.

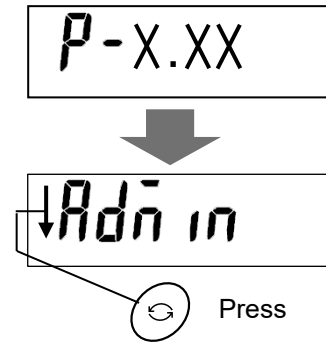

	Contents
<b>Adn in</b>	The set password is required to change the function table. No other restrictions.
<b>Guest</b>	The set password is not required to change the function table, but the parameters that can be changed in the function table are limited.



### 19.2.1. To Changing the Function Table in *Adn in*

1. Select **Adn in** and press the **TARE** key to display **PASSYd**.
2. After about 2 seconds, the password input screen appears. Refer to the table below to set the password and press the **TARE** key. If the password is correct, **Func** will be displayed; if it is wrong, **FRIL** will be displayed.
  - After displaying **FRIL**, it returns to the **Adn in** selection display.

Keys	Content
	Moves to the next item.
	Increases the blinking digit by 1.
	Sets the parameter.

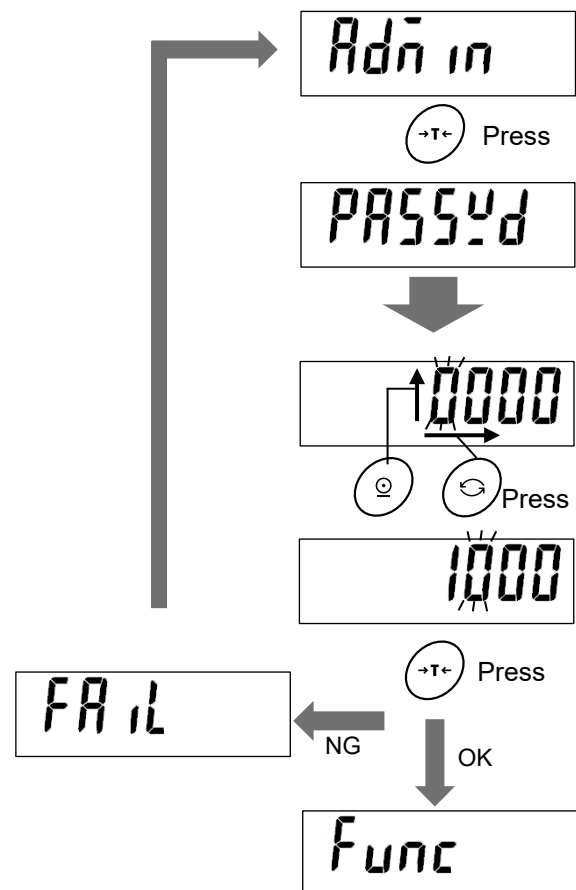



## 19.2.2. To Changing the Function Table in GUEST

1. Press the **MODE** key to select the **GUEST**, and then press the **TARE** key to display **Func**.
2. Press the **TARE** key to display the class. Refer to the table below to change items or set details. Refer to "19.2.3. List of Parameters that can be Changed in GUEST" regarding precision weighing.

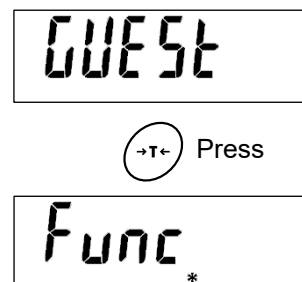

Keys	Content
	Moves to the next item.
	Increases the blinking digit by 1.
	Sets the parameter.



## 19.2.3. List of Parameters that can be Changed in GUEST

Class	Item	Parameter	Content/use
Func	Automatic power off function <b>PaFF</b>	◆ 0	OFF
		1	ON (Turns off after 5 minutes)
		2	ON (Turns off after 10 minutes)
		3	ON (Turns off after 15 minutes)
		4	ON (Turns off after 30 minutes)
		5	ON (Turns off after 60 minutes)
	Automatic power on function <b>P-an</b>	◆ 0	OFF
		1	ON (The scale turns on automatically if the power plug is connected.)
	Zero tracking function <b>trc</b>	0	OFF
		◆ 1	ON
	Backlight control <b>L-it</b>	0	Always turned off
		1	Always lit
		2	Brightness decreases at 1 minute after stabilizing
		3	Brightness decreases at 5 minutes after stabilizing
		4	Brightness decreases at 30 minutes after stabilizing
		◆ 5	Brightness decreases at 60 minutes after stabilizing
	Backlight brightness <b>L-i</b>	0	Dark
		◆ 1	↑↓
		2	↑↓
		3	Bright

◆: factory settings      d: readability (scale interval or "division")

Automatic power off: Turns the display off when the specified interval has passed, while the value is zero, the display is stable and there is no key operation.

Class	Item	Parameter	Content/use
Func	Serial interface Output mode [Prt]	♦ 0	Key mode
		1	Auto print mode A (Reference=zero point)
		2	Auto print mode B (Reference=last stable value)
		3	Stream mode
		4	Key mode B (Immediately)
		5	Command mode
		6	When comparator result is OK in Auto print mode A (Reference=zero point)
		7	When comparator result is OK in Auto print mode B (Reference=last stable value)
	Comparator comparison condition [CP]	♦ 0	Comparator function suspended
		1	Compare all data
		2	Compare all stable data
		3	Compare data except that at -4d to +4d
		4	Compare stable data except that at -4d to +4d
		5	Compare all data at +5d and above
	Comparator ordinary comparison / Negative comparison [P-P]	♦ 0	Ordinary comparison
		1	Negative comparison
	Impact Shock Detection [5d]	0	OFF
		♦ 1	ON

♦: factory settings      d: readability (scale interval or "division")



## 19.2.4. Forgotten Password

If you forget your password, you need to initialize it. Please refer to "[15.5. Restoring Function Tables to Factory Default](#)" for initialization.

- If you have forgotten the password, you need to initialize it. Refer to "[15.5. Restoring Function Tables to Factory Default](#)".



## 20. Legal-for-Trade mode instructions

The FG-CWP/FG-ACWP series is approved for trade.

The default setting is in normal-resolution mode. When the scale is to be used in a legal-for-trade (LFT) application, follow these instructions to put into LFT mode. You may also be required to have the FG-CWP/FG-ACWP verified and sealed in accordance with local weights and measures regulations.

Note: For U.S. customers, the scale has already been configured in a legal-for-trade (LFT) mode.

### 1. How to place into Legal-for-Trade mode

1. Press and Hold the **CAL** switch and press the **ON/OFF** key.

2. Select the mode by pressing the **PRINT** key.

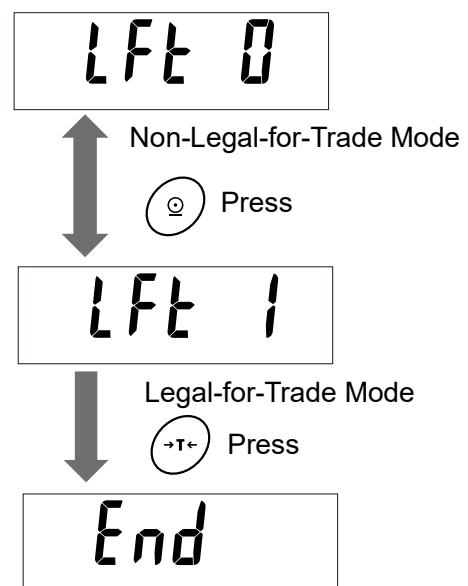

3. Press the **TARE** key to set the mode.

4. After displaying **End**, the display turns off.

### 2. Specifications for Legal-for-Trade mode (FG-CWP/FG-ACWP Series Class III Model)

Models		FG-30KCMWP FG-30KACMWP	FG-60KCLWP FG-60KACLWP	FG-150KCLWP FG-150KACLWP
Accuracy class		III		
kg	Maximum Capacity	30	60	150
	Readability	0.01	0.02	0.05
lb	Maximum Capacity	66	130	330
	Readability	0.02	0.05	0.1
oz	Maximum Capacity	1050	2100	5200
	Readability	0.5	1	2
Minimum capacity [kg]		0.2	0.4	1
Maximum tare [kg]		30	60	150

Refer to "22.1. Specifications List" as to the other specifications.

### **3. Functional restrictions for Legal-for-Trade mode (FG-CWP/FG-ACWP Series Class III Model)**

Functional restrictions:

- Readability is fixed. The selection in the function setting " " is not available. (Ref.: "8.3. Readability" and "15.6. Parameter list".)
- The range for power-on zero is within  $\pm 10\%$  of the weighing capacity (kg) around the sensitivity adjustment zero point. (Ref.: "6.2. Operation Keys".)
- The display units are lb, oz, kg, and pcs. The weighing unit "g" and "lb-oz" is disabled. (Ref.: "15.6. Parameter list".)
- The operation to enter sensitivity adjustment mode by using the  key is disabled. Using the CAL switch is only way to enter the sensitivity adjustment mode. (Ref.: "14.1. Sensitivity Adjustment Items".)
- The function setting " " is not displayed to select but is fixed to "t" internally. (Ref.: "15.6. Parameter list".)
- The function setting " " is not displayed to select but is fixed to "t" internally. (Ref.: "15.6. Parameter list".)

Power-on:

Turning the power on, the scale will be automatically set to zero.

If the power is switched on with a load within  $\pm 10\%$  of the weighing capacity at the sensitivity adjustment zero point (power-on zero range), the scale is zeroed and the ZERO indicator turns on.

If the load is beyond the power-on zero range, the scale is tared and the ZERO and the NET indicators turn on.

Error Message:

: Indicates that the gross value (weight value with no tare operation) is less than -19d. If the STABLE indicator is ON, press the  key to ZERO the scale. If the STABLE indicator is OFF, turn the power off and on again.

If these instructions do not work, there is a possibility that the weight sensor or internal circuit may have a problem.



## 21. Maintenance

- Refer to "4. Cautions" regarding use.
- Refer to "21.2. Error display" and corresponding mode for displayed error code.
- Refer to "14. Sensitivity Adjustment" regarding precision weighing.
- Periodically check the accuracy of weighing. Adjust the scale, if it is moved to another location or the environment has changed.



### 21.1. Repair

Do not disassemble / assemble the scale without an authorized service engineer. Doing so may cause an electric shock or damage to the scale, etc. In this case, repair is not covered under warranty. Contact your local A&D dealer if your scale needs service or repair.



### 21.2. Error display

In this situation	Confirm these items
Nothing displayed. Scale does not turn on.	<ul style="list-style-type: none"> <li>• Is the main power the correct voltage?</li> <li>• Is the main power cord properly connected?</li> </ul>
The scale does not display zero at first.	<ul style="list-style-type: none"> <li>• Check around the weighing pan.</li> <li>• Is there anything on the weighing pan?</li> <li>• Refer to "14. Sensitivity Adjustment" and perform zero point sensitivity adjustment.</li> </ul>
<input type="text" value="E"/> is displayed.	<ul style="list-style-type: none"> <li>• Weighing error that meaning "Over loaded."</li> </ul>
<input type="text" value="Lo ut"/> is displayed.	<ul style="list-style-type: none"> <li>• Indicates that the sample weight is too light to set the unit weight in counting mode.</li> </ul>
<input type="text" value="-ERR E"/> is displayed.	<ul style="list-style-type: none"> <li>• Sensitivity adjustment error that meaning "Too light."</li> </ul>
<input type="text" value="Lb"/> is displayed.	<ul style="list-style-type: none"> <li>• Displayed when the main power drops.</li> </ul>
<input type="text" value="-----"/> is displayed and does not proceed.	<ul style="list-style-type: none"> <li>• The weighed value is unstable due to drift, vibration or other factors. A breeze or vibration may be affecting measurement. Check around the weighing pan.</li> <li>• Check the connection of the load cell cable.</li> <li>• No zero display when the display is turned on. Remove anything that is on the pan.</li> <li>• Perform zero point adjustment.</li> </ul>
Fixed display.	<ul style="list-style-type: none"> <li>• Did you use the hold function ? Refer to "15. Function Table" and change the function <input type="text" value="Hold"/>.</li> <li>• Turn off scale and turn it on again.</li> </ul>



## 21.3. Error Code Table

When any of the following errors are displayed, try turning the display off and on again.

Display	Content
Error 0 is displayed	The temperature sensor has failed.
Error 3 is displayed	The memory (circuit) has failed.
Error 4 is displayed	The internal circuitry has failed.
Error 5 is displayed	The mass sensor has failed.



## 22. Specifications



### 22.1. Specifications List

Models		FG-30KCMWP FG-30KACMWP	FG-60KCLWP FG-60KACLWP	FG-150KCLWP FG-150KACLWP
kg	Weighing Capacity	30	60	150
	Readability	0.01	0.02	0.05
		0.005 *	0.01 *	0.02 *
		0.002	0.005	0.01
	0.001	0.002	0.005	
g	Weighing Capacity	30000	/	/
	Readability	10		
		5 *		
		2		
	1			
lb	Weighing Capacity	66	130	330
	Readability	0.02	0.05	0.1
		0.01 *	0.02 *	0.05 *
		0.005	0.01	0.02
	0.002	0.005	0.01	
oz	Weighing Capacity	1050	2100	5200
	Readability	0.5	1	2
		0.2 *	0.5 *	1 *
		0.1	0.2	0.5
	0.05	0.1	0.2	
lb-oz	Weighing Capacity	66	130	330
	Readability	0.1	1	1
Number of Samples		5 pcs (can be changed to 10 pcs , 20 pcs, 50 pcs or 100 pcs)		
Maximum Count Number		300,000 pcs		
Minimum Unit Mass [kg]		0.0001	0.0002	0.0005
Repeatability (Standard Deviation) [kg]		0.005	0.01	0.02
Linearity [kg]		±0.01	±0.02	±0.05
Stabilization time (good environment)		20kg:Approx. 1.0 sec (Factory setting) Approx. 0.8 sec (Land U setting)		
Temperature Drift		±20 ppm/°C typ. (5 °C to 35 °C)		
Display		7 segment LCD with backlight (Character height 30 mm)		
Display update		Approx. 10 times/second		
Dust and water protection		Complying with IP67		
Operating Conditions		-10 °C to 40 °C, 85% R.H. or less (non-condensing)		
Installation environment		Indoor use only		
Altitude		Altitude up to 2,000 m		
Power Supply		<FG-CWP Series (USB power model)> Power supplied from AC adapter, mobile battery, or USB Type-A port USB Cable Length: Approx. 3 m (USB cable is also used for communication) <FG-ACWP Series (AC power model)> AC mains (100 V to 240 V, 50/60 Hz, 0.1 A Max) AC Cable Length: Approx. 3 m		
Overvoltage category **		II		
Pollution degree **		2		
Weighing Pan Size [mm]		300 x 380	370 x 500	
Dimension [mm] Width x Depth x Height		300 x 515 x 784	370 x 635 x 784	
Weight (approximately)		11.1 kg 24.5 lb	12.8 kg 28.3 lb	
Sensitivity adjustment weight (factory setting)		30 kg 60 lb	60 kg 120 lb	150 kg 300 lb

\* Factory setting

\*\* Applicable to FG-ACWP Series (AC power model) only

For Class III approved model specifications, refer to "20. Legal-for-Trade mode instructions".

## 22.2. Dimensions

FG-30KCMWP/FG-30KACMWP

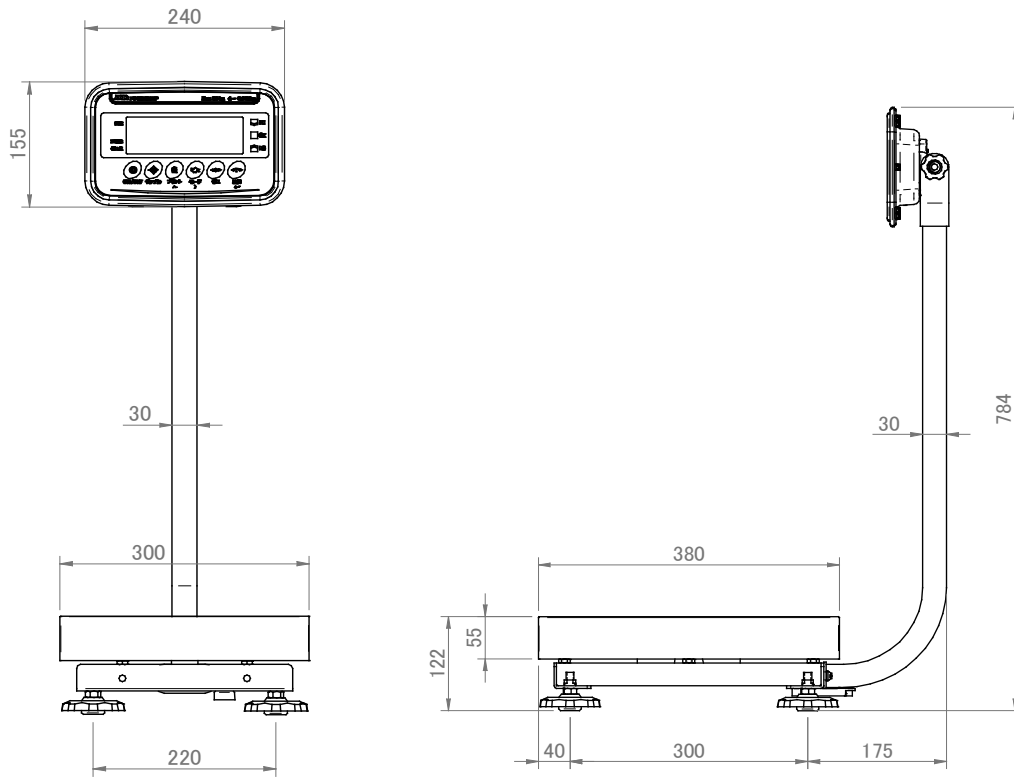

FG-60KCLWP/FG-60KACLWP  
FG-150KCLWP/FG-150KACLWP

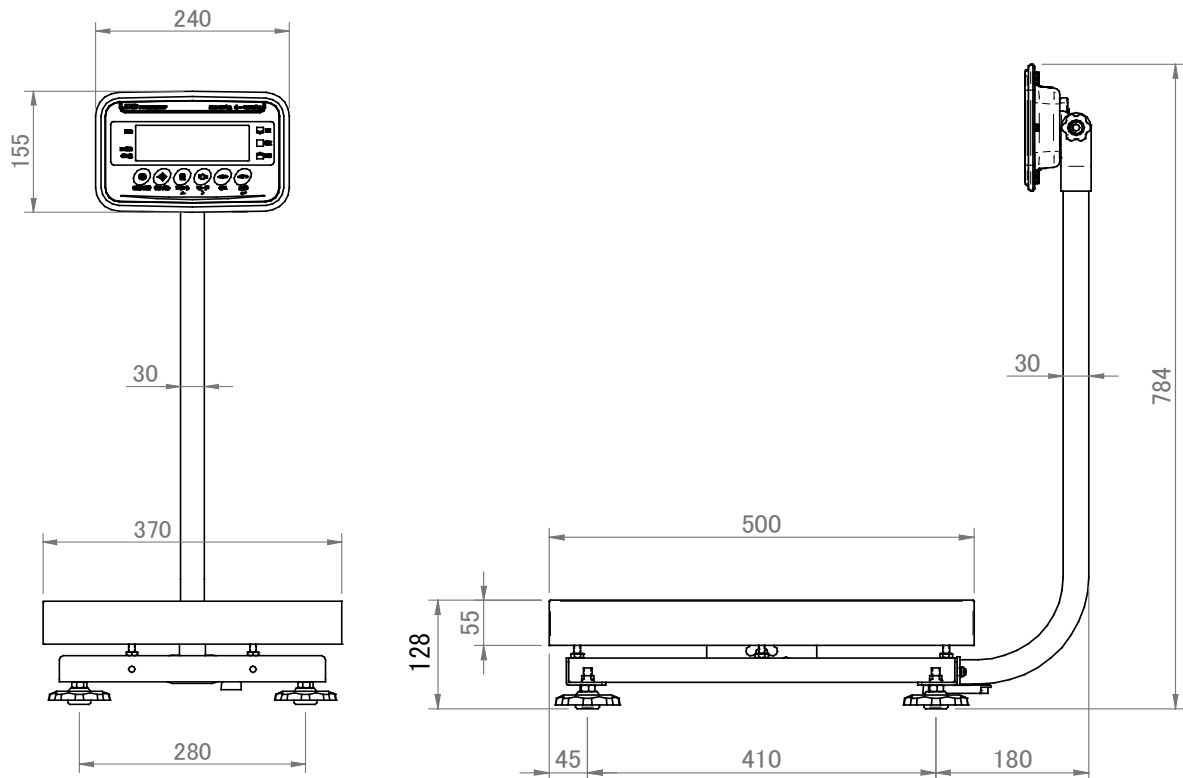



# Gravity Acceleration Map

## Values of gravity at various locations

Amsterdam	9.813 m/s <sup>2</sup>	Manila	9.784 m/s <sup>2</sup>
Athens	9.800 m/s <sup>2</sup>	Melbourne	9.800 m/s <sup>2</sup>
Auckland NZ	9.799 m/s <sup>2</sup>	Mexico City	9.786 m/s <sup>2</sup>
Bangkok	9.783 m/s <sup>2</sup>	Milan	9.807 m/s <sup>2</sup>
Birmingham	9.813 m/s <sup>2</sup>	Moscow	9.816 m/s <sup>2</sup>
Brussels	9.811 m/s <sup>2</sup>	New York	9.802 m/s <sup>2</sup>
Buenos Aires	9.797 m/s <sup>2</sup>	Oslo	9.819 m/s <sup>2</sup>
Cape Town	9.796 m/s <sup>2</sup>	Ottawa	9.807 m/s <sup>2</sup>
Chicago	9.803 m/s <sup>2</sup>	Paris	9.810 m/s <sup>2</sup>
Copenhagen	9.816 m/s <sup>2</sup>	Rio de Janeiro	9.788 m/s <sup>2</sup>
Cyprus	9.797 m/s <sup>2</sup>	Rome	9.803 m/s <sup>2</sup>
Frankfurt	9.811 m/s <sup>2</sup>	San Francisco	9.800 m/s <sup>2</sup>
Glasgow	9.816 m/s <sup>2</sup>	Singapore	9.780 m/s <sup>2</sup>
Havana	9.788 m/s <sup>2</sup>	Stockholm	9.819 m/s <sup>2</sup>
Helsinki	9.819 m/s <sup>2</sup>	Sydney	9.796 m/s <sup>2</sup>
Jakarta	9.781 m/s <sup>2</sup>	Taichung	9.789 m/s <sup>2</sup>
Kolkata (Calcutta)	9.788 m/s <sup>2</sup>	Taipei	9.790 m/s <sup>2</sup>
Kuwait	9.793 m/s <sup>2</sup>	Tokyo	9.798 m/s <sup>2</sup>
Lisbon	9.801 m/s <sup>2</sup>	Vancouver, BC	9.810 m/s <sup>2</sup>
London (Greenwich)	9.812 m/s <sup>2</sup>	Washington DC	9.801 m/s <sup>2</sup>
Los Angeles	9.797 m/s <sup>2</sup>	Wellington NZ	9.803 m/s <sup>2</sup>
Madrid	9.802 m/s <sup>2</sup>	Zurich	9.808 m/s <sup>2</sup>

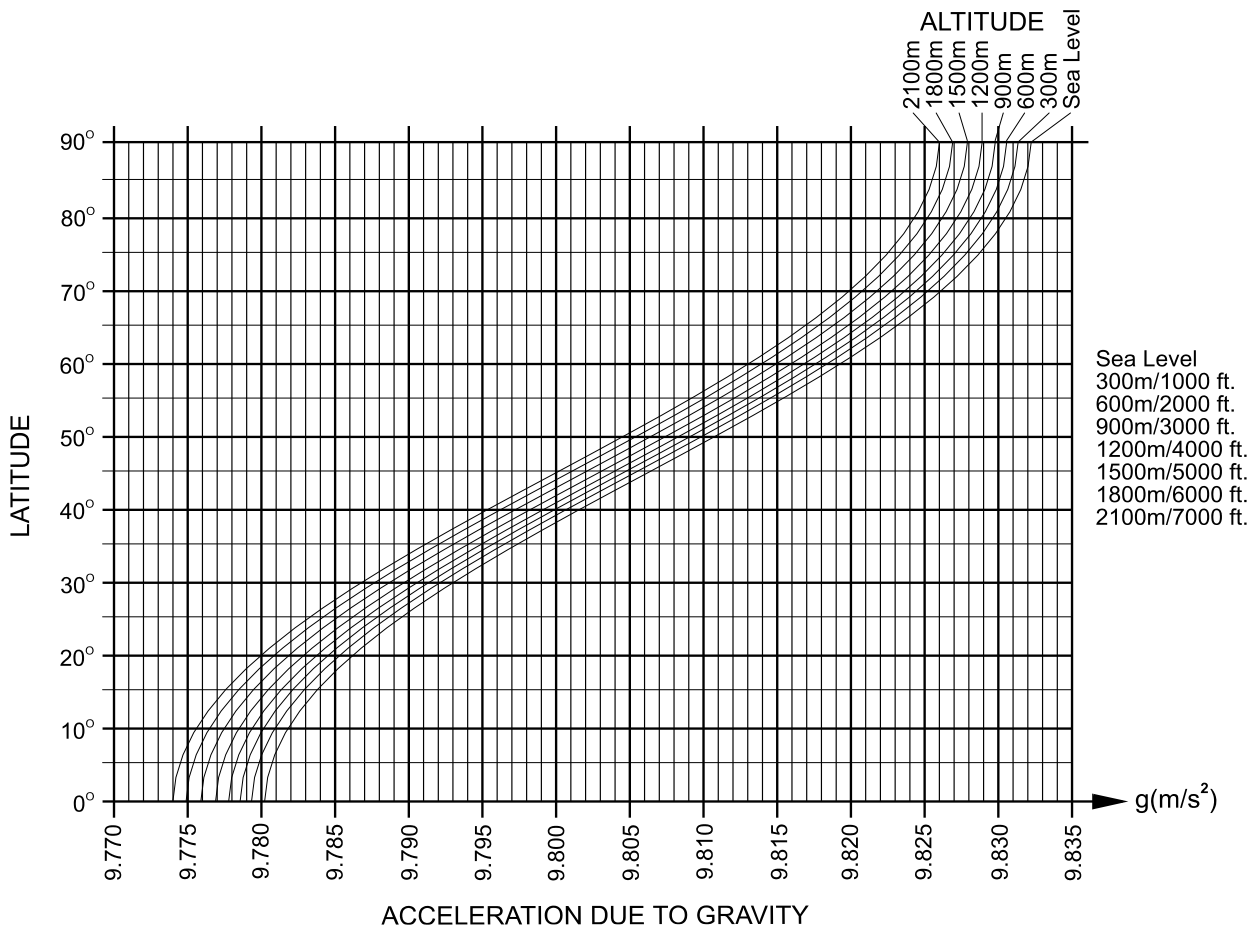





THIS PAGE INTENTIONALLY LEFT BLANK.



## **A&D Company, Limited**

3-23-14 Higashi-Ikebukuro, Toshima-ku, Tokyo 170-0013, JAPAN  
Telephone: [81] (3) 5391-6132 Fax: [81] (3) 5391-1566

## **A&D ENGINEERING, INC.**

Headquarters Office: 4622 Runway Boulevard, Ann Arbor, Michigan 48108, U.S.A.  
Sales Office: 47747 Warm Springs Boulevard, Fremont, California 94539, U.S.A.  
Tel: [1] (800) 726-3364 Weighing Support: [1] (888) 726-5931 Inspection Support: [1] (855) 332-8815

## **A&D INSTRUMENTS LIMITED**

Unit 24/26 Blacklands Way, Abingdon Business Park, Abingdon, Oxfordshire OX14 1DY United Kingdom  
Telephone: [44] (1235) 550420 Fax: [44] (1235) 550485

## **A&D AUSTRALASIA PTY LTD**

32 Dew Street, Thebarton, South Australia 5031, AUSTRALIA  
Telephone: [61] (8) 8301-8100 Fax: [61] (8) 8352-7409

## **A&D KOREA Limited**

한국에이.엔.디(주)  
서울특별시 영등포구 국제금융로6길33 (여의도동) 맨하탄빌딩 817 우편 번호 07331  
( 817, Manhattan Bldg., 33. Gukjegeumyung-ro 6-gil, Yeongdeungpo-gu, Seoul, 07331 Korea )  
전화: [82] (2) 780-4101 팩스: [82] (2) 782-4264

## **OOO A&D RUS**

ООО "ЭЙ энд ДИ РУС"  
Почтовый адрес: 121357, Российская Федерация, г. Москва, ул. Вереysкая, дом 17  
Юридический адрес: 117545, Российская Федерация, г. Москва, ул. Дорожная, д.3, корп.6, комн. 86  
( 121357, Russian Federation, Moscow, Vereyskaya Street 17 )  
тел.: [7] (495) 937-33-44 факс: [7] (495) 937-55-66

## **A&D Instruments India Private Limited**

ऐ&डी इन्स्ट्रुमेंट्स इण्डिया प्रा० लिमिटेड  
D-48, उद्योग विहार , फेस -5, गुडगांव - 122016, हरियाणा , भारत  
( D-48, Udyog Vihar, Phase-V, Gurgaon - 122016, Haryana, India )  
फोन : [91] (124) 4715555 फैक्स : [91] (124) 4715599

## **A&D SCIENTECH TAIWAN LIMITED.**

艾安得股份有限公司  
台湾台北市中山區南京東路 2 段 206 號 11 樓之 2  
( 11F-2, No.206, Sec.2, Nanjing E.Rd., Zhongshan Dist., Taipei City 10489, Taiwan, R.O.C. )  
Tel : [886](02) 2322-4722 Fax : [886](02) 2392-1794

## **A&D INSTRUMENTS (THAILAND) LIMITED**

บริษัท เอ แอนด์ ดี อินสตรูमेंท์ (ไทยแลนด์) จำกัด  
168/16 หมู่ที่ 1 ตำบลรังสิต อำเภอธัญบุรี จังหวัดปทุมธานี 12110 ประเทศไทย  
( 168/16 Moo 1, Rangsit, Thanyaburi, Pathumthani 12110 Thailand )  
Tel : [66] 20038911