

EK-EP Series

Explosion-Proof Compact Balance



EK-300EP / EK-3000EP / EK-12KEP

INSTRUCTION MANUAL

AND
A&D Company, Limited

This Manual and Marks

All safety messages are identified by the following, "DANGER", "WARNING" or "CAUTION", of ANSI Z535.4 (American National Standard Institute: Product Safety Signs and Labels). The meanings are as follows:

 DANGER	An imminently hazardous situation which, if not avoided, will result in death or serious injury.
 WARNING	A potentially hazardous situation, which if not avoided, could result in death or serious injury.
 CAUTION	A potentially hazardous situation, which if not avoided, may result in minor or moderate injury.



This is a hazard alert mark.

Note This manual is subject to change without notice at any time to improve the product. No part of this manual may be photocopied, reproduced, or translated into another language without the prior written consent of A&D Company, Limited.

Product specifications are subject to change without any obligation on the part of the manufacturer.

Compliance with FCC rules

Please note that this equipment generates, uses and can radiate radio frequency energy. This equipment has been tested and has been found to comply with the limits of a Class A computing device pursuant to Subpart J of Part 15 of FCC rules. These rules are designed to provide reasonable protection against interference when this equipment is operated in a commercial environment. If this unit is operated in a residential area it might cause some interference and under these circumstances the user would be required to take, at his own expense, whatever measures are necessary to eliminate the interference. (FCC = Federal Communications Commission in the U.S.A.)

Copyright©2015 A&D Company, Limited

CONTENTS

1. INTRODUCTION	3
2. UNPACKING	3
3. PRECAUTIONS	4
3-1. Precautions on Explosion-Proof Structure	4
3-2. Precautions on Installation.....	4
3-2. Precautions on Power Source	5
4. SETTING UP	6
4-1. Setting up Your Balance	6
4-2. Installing/Replacing the Batteries	6
4-3. When Weighing Objects that are Prone to Static Electricity.....	7
5. CONFORMING STANDARDS	8
5-1. IECEx	8
5-2. ATEX	8
5-3. FM (Zone).....	8
5-4. FM (Division)	8
6. PART NAMES AND FUNCTIONS	9
7. OPERATION	10
7-1. Turn the Power ON and OFF	10
7-2. LCD Backlight.....	10
7-3. Units	11
7-4. Selecting a Weighing Unit.....	12
7-5. Basic Operation	12
7-6. Counting Mode (pcs)	13
7-7. Percent Mode (%).....	15
8. COMPARATOR	16
8-1. Setting Example	16
9. CALIBRATION	18
9-1. Calibration Using a Weight	18
9-2. Gravity Acceleration Correction	20
10. FUNCTIONS	21
10-1. Key Operation.....	21
10-2. Entering the Function Setting Mode	21
10-3. Setting Example	22
10-4. Storing Weighing Units	23
10-5. Function List	24
11. OPTION	25
12. MAINTENANCE	26
12-1. Notes on Maintenance.....	26

12-2. Error Codes	26
13. SPECIFICATIONS	28
13-1. Specifications.....	28
13-2. Option.....	28
13-3. External Dimensions.....	28
13-4. Other Weighing Units.....	29
GRAVITY ACCELERATION MAP	30

1. INTRODUCTION

This manual describes how this balance works and how to get the most out of it in terms of performance.

The EK-EP series balances have the following features:

- The EK-EP series are intrinsically safe electronic balances complying with international standards such as IECEx and ATEX or FM requirements.
- The EK-EP series balances can be used in areas where explosive atmospheres are present. (For details on the explosion-proof structure, refer to “5. CONFORMING STANDARDS.”)
- The EK-EP series are high-resolution type electronic balances having a display resolution of 1/12,000 or 1/30,000.
- The balance has a counting function, a percent function and a comparator function.
- The LCD backlight will help with use in a dimly lighted place.
- As a power source, four “AA”, “LR6” or “AM3” batteries are used.

2. UNPACKING

When unpacking, check whether all of the following items are included:

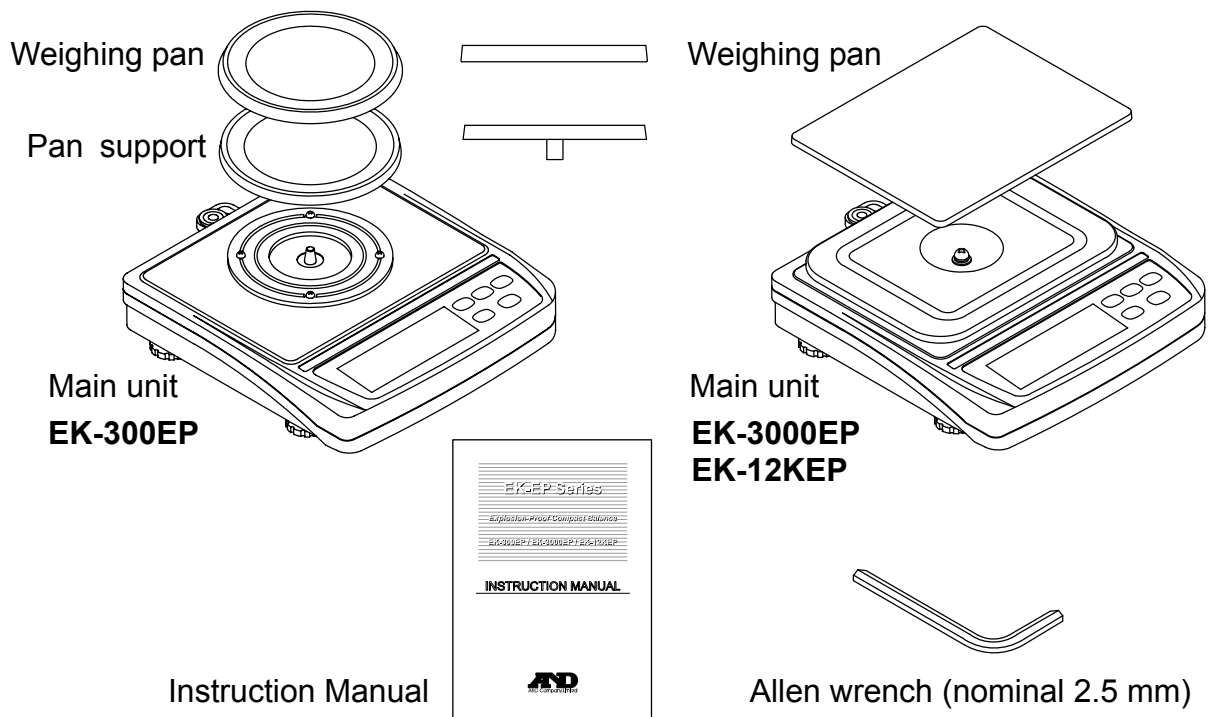

- Keep the packing material to be used for transporting the balance in the future.
- The weighing pan shape depends on the balance model. The operational procedure is the same for all the balance models. Unless specially required, the illustration of the rectangle-shaped weighing pan is used in this manual.

3. PRECAUTIONS

3-1. Precautions on Explosion-Proof Structure

 **DANGER**

- Do not disassemble or modify the balance.
- When determining the installation site, take the following into consideration.
Will explosive gases be generated? How often will they be generated?
Refer to “5. CONFORMING STANDARDS.”
- The enclosure of the balance contains accessible metal parts and could be susceptible to electrostatic charges that could be a source of ignition. The user must consider a value of 170pF capacitance when considering suitability for use. Refer to IEC TS60079.32-1 for guidance.
- Part of the enclosure is constructed of plastic. To prevent the risk of electrostatic sparking, clean the non-metallic surface only with a damp cloth.
- Replace the batteries in non-hazardous areas.
- As a power source, only the four “AA”, “LR6” or “AM3” alkaline 1.5 V batteries listed below can be used.
DURACELL MN1500, ENERGIZER E91, Panasonic LR6(XJ)
- When replacing the batteries, be sure to prevent foreign materials from entering the battery compartment.





3-2. Precautions on Installation

- Do not install the balance where corrosive gases are present.
- Do not install the balance where the balance will get wet or soaked with water.
- Do not install the balance where the balance will be exposed to direct sunlight, drafts, vibration, large temperature fluctuations, condensation or magnetism.
- Do not install the balance near air conditioners or heaters.
- Use a solid weighing table to keep the balance level.
- Level the balance by adjusting the leveling feet and confirm it using the bubble spirit level.
- Allow the balance to reach equilibrium with the ambient temperature before use.

3-2. Precautions on Power Source

As a power source, only the four “AA”, “LR6” or “AM3” alkaline 1.5 V batteries listed below can be used.

DURACELL MN1500, ENERGIZER E91, Panasonic LR6(XJ)

-  **WARNING** The explosion-proof performance of the EK-EP series balance is guaranteed by using the batteries described above. Do not use other types of batteries or rechargeable batteries.
-  **DANGER** Replace the batteries in non-hazardous areas.
-  **DANGER** Do not disassemble the batteries or short-circuit the battery electrodes.
-  **WARNING** Install new batteries with terminals (+, -) aligned correctly.
-  **WARNING** Do not mix old and new batteries, battery types or batteries of other manufacturers. It may cause the batteries to leak or burst, or cause the balance to malfunction.
- When “*Lb0*” appears in the display during use, stop using the balance immediately and replace all four batteries with new ones.
- The battery life depends on the ambient temperature and the use of the balance.
- Remove the batteries if the balance is not to be used for a long period of time. The batteries may leak and cause a malfunction.
- Observe the precautions written on the batteries.
- Damage caused by battery leakage will void the warranty.

4. SETTING UP

Read "3. PRECAUTIONS" carefully and install the balance as described below.

4-1. Setting up Your Balance

1. Set up the balance as shown below.

EK-300EP: Install the pan support and the weighing pan on the main unit.

EK-3000EP/EK-12KEP: Install the weighing pan on the main unit.

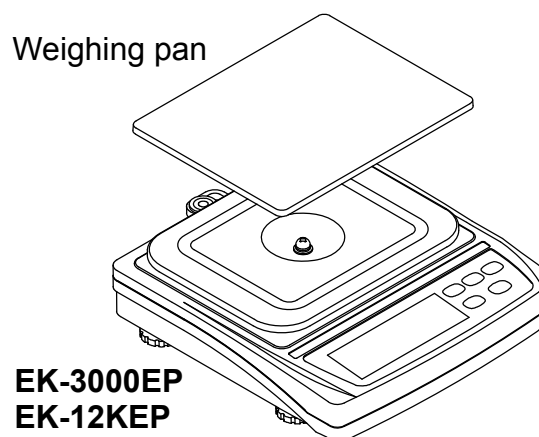
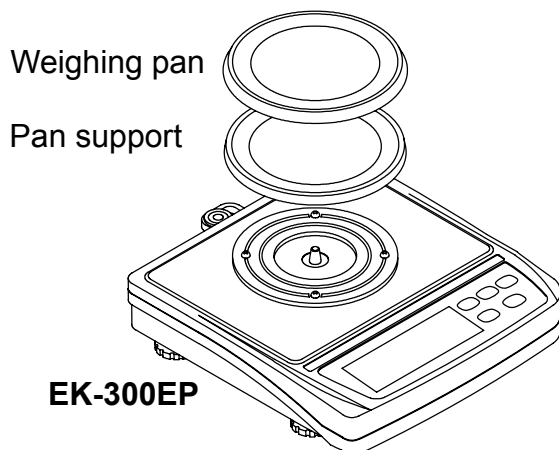

2. Place the balance on a solid and level surface. Adjust the level of the balance using the leveling feet. Use the spirit level to confirm. The bubble should be in the center of the circle.
3. When the balance is installed for the first time, or the balance has been moved, carry out calibration as described in "9. CALIBRATION."

4-2. Installing/Replacing the Batteries

As a power source, only the four "AA", "LR6" or "AM3" alkaline 1.5 V batteries listed below can be used.

DURACELL MN1500, ENERGIZER E91, Panasonic LR6(XJ)

The batteries are not provided and must be prepared by the user.



DANGER Install or replace the batteries in non-hazardous areas.

1. Using the Allen wrench provided, remove the battery cover securing screws.
2. While pressing the battery cover, slide it in the direction indicated by the arrow and remove the cover. Remove the old batteries.
3. Insert four new batteries (AA, LR6 or AM3 size) into the battery compartment, with the terminals (+, -) aligned correctly.

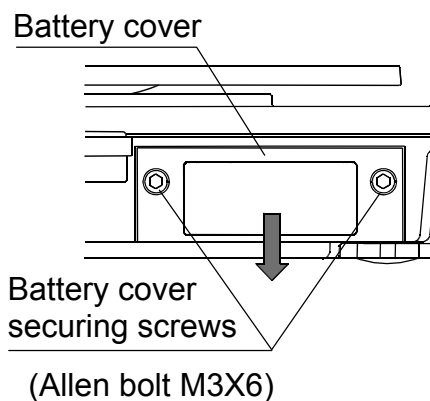

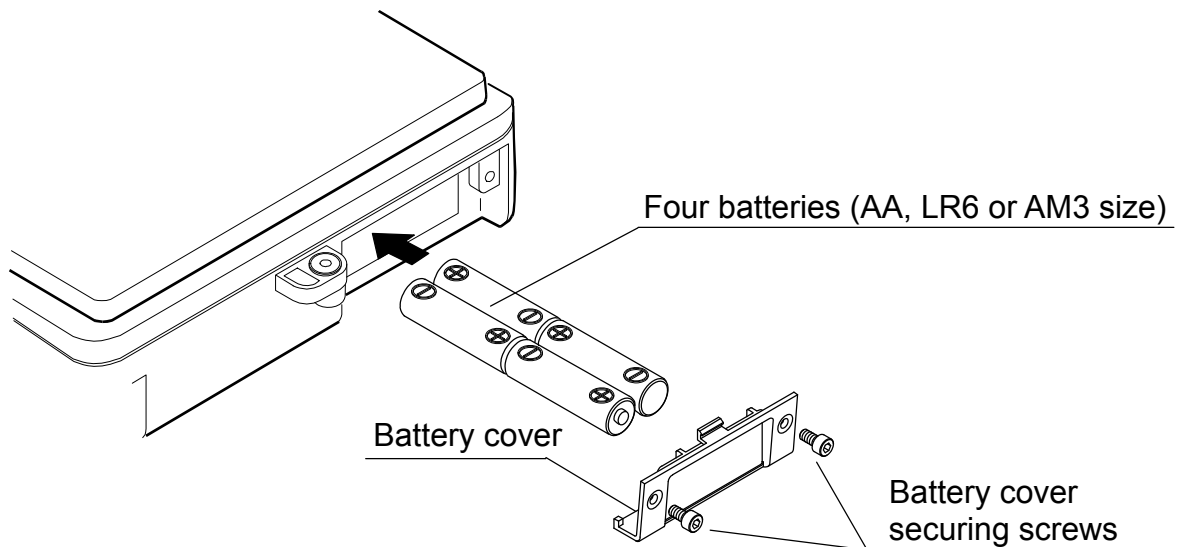

4. Attach the battery cover and secure it to the balance using the battery cover securing screws.

- During use, the battery indicator changes as the battery voltage decreases, as shown below.

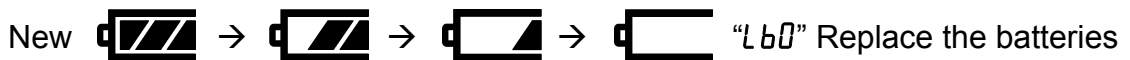

- When “Lb0” appears in the display during use, stop using the balance immediately and replace all four batteries with new ones.

4-3. When Weighing Objects that are Prone to Static Electricity

- When the ambient humidity is low, insulating materials such as plastics are prone to static electricity. Weighing those with a static charge will result in unstable or incorrect weight values.

Under such a situation, ground the balance using the grounding screw hole. Grounding will reduce the influence of static electricity.

- A grounding wire or a screw is not provided and must be prepared by the user. Use an M3 screw with a nominal length of 12 mm or less.

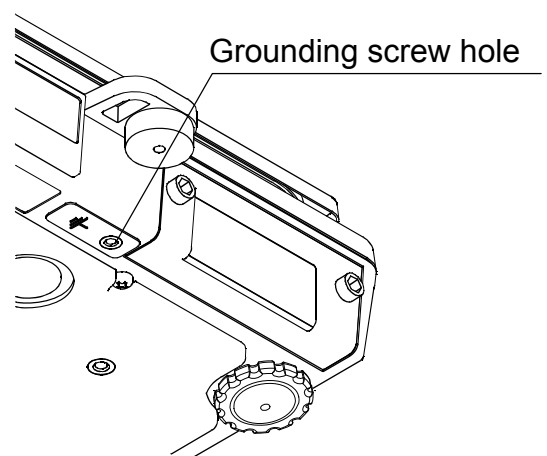

5. CONFORMING STANDARDS

5-1. IECEx

Ex ia IIB T3 Ga

Ex: Ex Component
ia: Type of Protection
IIB: Gas Classification
T3: Temperature Class
Ga: Equipment Protection Level

5-2. ATEX

II 1G Ex ia IIB T3 Ga

Ex: Ex Component
ia: Type of Protection
IIB: Gas Classification
T3: Temperature Class
Ga: Equipment Protection Level

5-3. FM, FMc (Zone)

Class I, Zone 0, AEx / Ex ia IIB T3

Class: Permitted Class
Zone: Permitted Zone
Ex: Ex Component
(AEx: American National Standard)
ia: Type of Protection
IIB: Gas Classification
T3: Temperature Class

5-4. FM, FMc (Division)

Intrinsically Safe for Class I, Division 1, Groups C, D T3C

Intrinsically Safe: Type of Protection
Class: Permitted Class
Division: Permitted Division
Groups: Permitted Groups
T3C: Temperature Class

6. PART NAMES AND FUNCTIONS

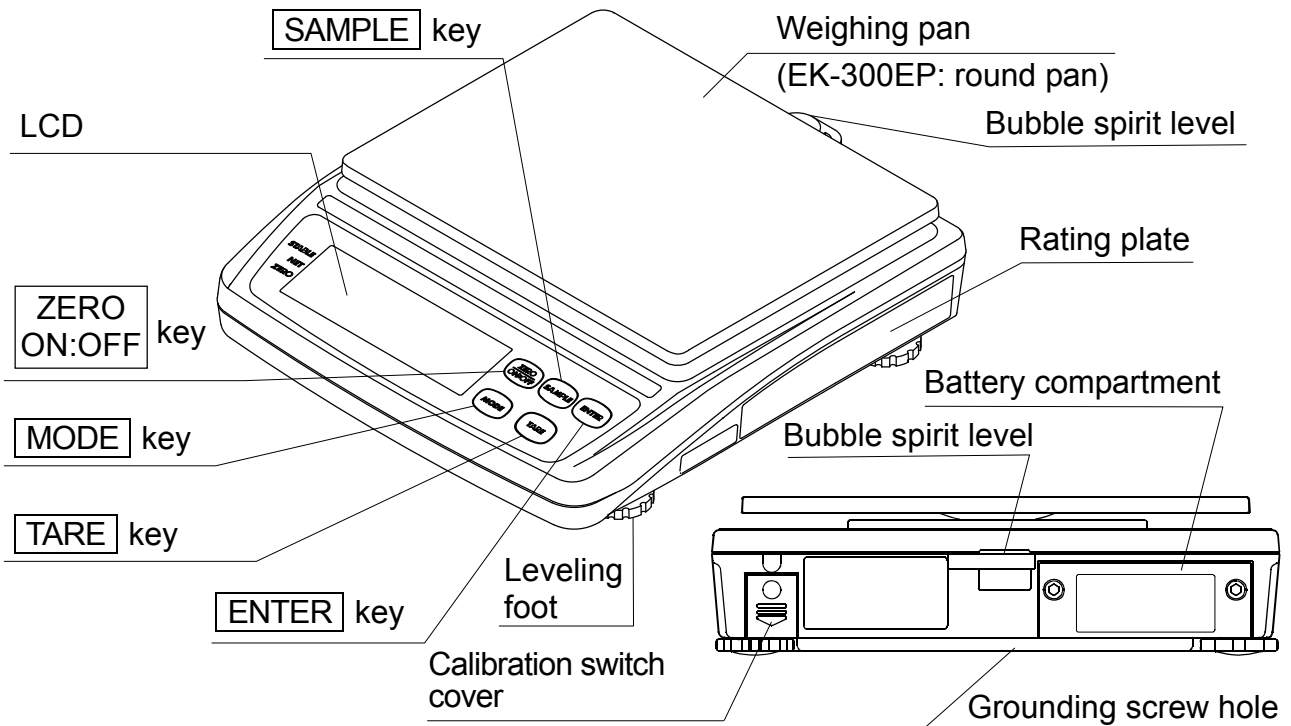

LCD

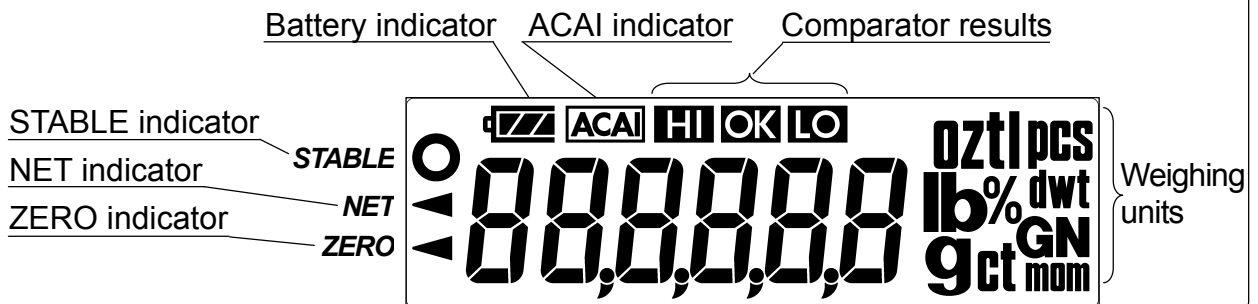

ZERO/ON:OFF key

Turns the power ON. Sets the zero point in the weighing mode.
Turns the power OFF when held down while the power is ON.



TARE key

Tares the load on the weighing pan and clears the display to zero.



MODE key

Switches the weighing units.



ENTER key

Sets a unit weight, 100% weight or other setting values.



SAMPLE key

Held down to enter the function setting mode.
Counting mode (pcs).....Enters the sample unit weight storing mode.
Percent mode (%).....Enters the 100% weight storing mode.

7. OPERATION

7-1. Turn the Power ON and OFF

- ❑ Place nothing on the weighing pan.

1. Press the **ZERO/ON:OFF** key to turn the power ON.



All of the symbols are displayed as shown above.
(About units: Only the available units will be displayed.)

The display turns off except for a weighing unit and the decimal point.
The balance waits for the weight value to become stable, and then, zero will be displayed with the ZERO indicator (power-on zero).

The range for power-on zero is within $\pm 10\%$ of the weighing capacity around the calibrated zero point.

If the power is turned ON while there is a load beyond this range, the balance will be tared to zero and the NET and ZERO indicators turn on.

- ❑ The weighing range is from the zero point to the maximum weighing capacity. When tared, weighing can be performed up to the weighing capacity minus the tare value.

2. Press and hold the **ZERO/ON:OFF** key to turn the power OFF.

- ❑ **Auto power-off function**

The auto power-off function automatically turns the power OFF when zero is displayed for approximately 5 minutes.

Refer to "10-5. Function List" and set the function "P_{OFF}."

7-2. LCD Backlight

The LCD backlight will turn on when the weight value changes more than $4d^*$ or any key operation is performed. When the weight value becomes and stays stable for a certain period of time, the backlight will automatically turn off. There is also a setting that the backlight is always on or off. For details, refer to the function setting "LEUP" of "10-5. Function List."

* d =minimum display division, refer to "13. SPECIFICATIONS."
e.g.: "d" for the EK-300EP is 0.01 g. Therefore, $4d$ is 0.04 g.

7-3. Units

The most common unit of weight used around the world is the gram, but there is often a need to shift to alternative units specific to the country where the balance is used or to select modes such as counting or percent.

The units and the order they appear in the display are as follows:

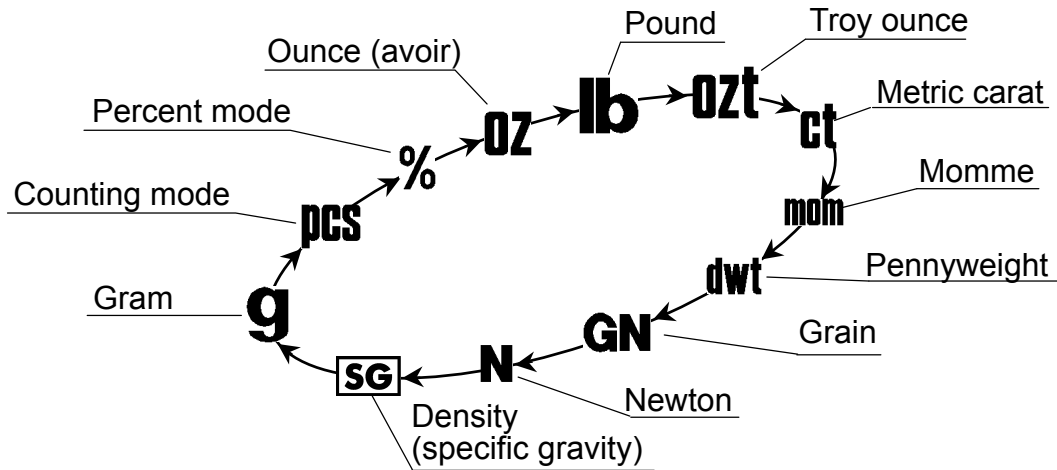

Among the units, those available for the user have been set at the factory before shipping.

The unit can be selected in the function setting mode. The order of the units available is the same as above.

□ Note

It is possible to store only the units that will be actually used from the units available. It is also possible to specify the unit that will appear first when the power is turned ON. For details, Refer to “8-4. Storing Weighing Units.”

Conversion table

Units	Name	Conversion to gram
oz	Ounce (avoir)	28.349523125 g
lb	Pound (UK)	453.59237 g
ozt	Troy ounce	31.1034768 g
ct	Metric carat	0.2 g
mom	momme	3.75 g
dwt	Pennyweight	1.55517384 g
GN	Grain (UK)	0.06479891 g
t	tola	11.6638038 g
tl	tael (Hong Kong general, Singapore)	37.7994 g
tl	tael (Hong Kong jewelry)	37.4290 g
tl	tael (Taiwan)	37.5 g

- “Newton” is the value calculated by “(g value) x (9.80665 m/s²) / 1000.”
- The unit “t (tola)” and three kinds of “tl (tael)” are for special versions only. One of them can be selected and installed at the factory.

7-4. Selecting a Weighing Unit

Press the **MODE** key to select a unit.

The following sections are a description of the three common units: g (gram mode), pcs (counting mode), and % (percent mode).

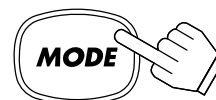

Each pressing switches the units available in the order described on the previous page.

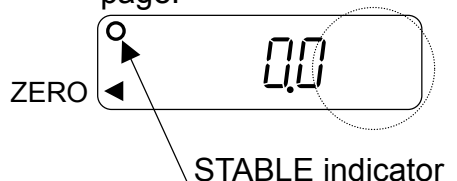

7-5. Basic Operation

1. Select a weighing unit.
2. When the display does not show zero, press the **ZERO/ON:OFF** key to set the display to zero.
3. When using a tare (container), place the container on the pan, and press the **TARE** key to set the display to zero.
4. Place the object to be weighed on the pan or in the container.
Wait for the STABLE indicator to turn on and read the value.

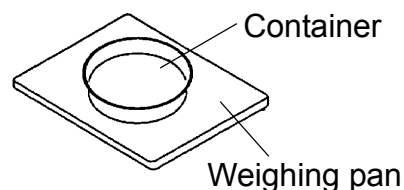

5. Remove the object from the pan.

- The **ZERO/ON:OFF** key will zero the balance if the weight is within $\pm 2\%$ of the weighing capacity around the power-on zero point. The ZERO indicator \blacktriangleleft turns on. When the weight exceeds $\pm 2\%$ of the weighing capacity, the balance will not be zeroed.
- The **TARE** key will tare the balance up to the positive value corresponding to the weighing capacity. In this case the NET and ZERO indicators turn on.
- The weighing range is from the zero point to the maximum weighing capacity. When tared, weighing can be performed up to the weighing capacity minus the tare value.
- When the **ZERO/ON:OFF** key (zero setting) or the **TARE** key is recognized, the display turns off except for a weighing unit and the decimal point. The balance waits for the weight value to become stable and then performs each function.

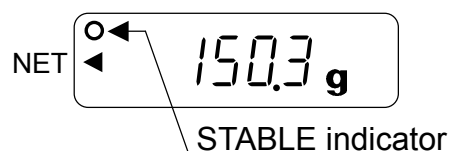
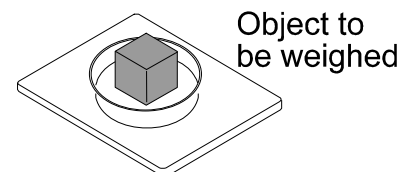

CAUTION

Precautions during operation

- Make sure that the STABLE indicator is on whenever reading or storing a value.
- Do not press the keys with a sharp object such as a pencil.
- Do not apply a shock or a load to the pan that is beyond the weighing capacity.
- Keep the balance free from foreign objects such as dust or liquid.
- Calibrate the balance periodically to maintain weighing accuracy. (Refer to "9. CALIBRATION.")

7-6. Counting Mode (pcs)

The balance weighs the sample pieces and calculates the unit weight. Using the sample unit weight, the balance counts the number of objects in the sample.

- ❑ As for the minimum unit weight acceptable, refer to the function setting “ $\bar{U}n$ in 1” of “10-5. Function List.” Please note that “ $\bar{U}n$ in 1” and “ $\bar{U}n$ in 2” are for counting light objects, not for improving counting accuracy.
- ❑ The sample unit weight is stored in memory even if power to the balance is turned OFF.

Selecting the counting mode

1. Press the **MODE** key to select **pcs**.

(**pcs** :pieces)

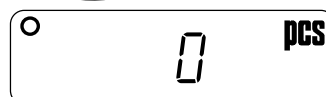
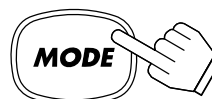

Storing the sample unit

2. Press the **SAMPLE** key to enter the sample unit weight storing mode.

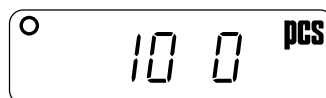
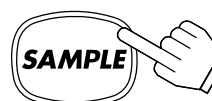

3. To select the number of samples, press the **SAMPLe** key. It may be set to 5, 10, 25, 50, or 100.

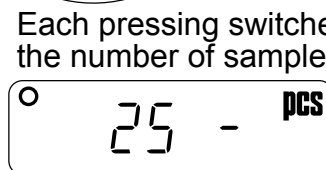
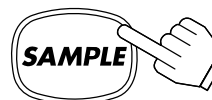

Each pressing switches the number of samples.

- ❑ When zero (0) is not displayed to the right side of the number of samples, as in the figure on the right, press the **ZERO/ON:OFF** key to set it to zero.

4. Place a tare container on the weighing pan, and press the **TARE** key. Confirm that zero is displayed to the right side of the number of samples.

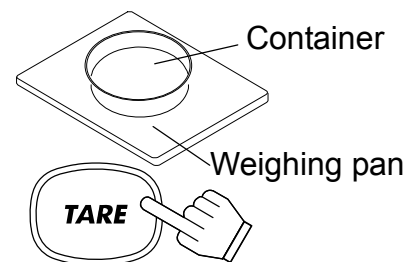

Confirm the zero display

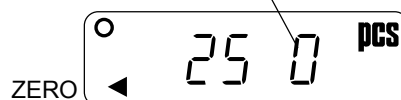

5. Place the number of samples specified on the pan. In this example, 25 pieces.

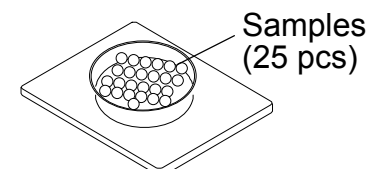

6. Press the **ENTER** key to calculate and store the unit weight. Remove the sample.

The balance has been set to count objects with this sample unit weight.



To store

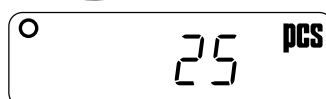

- If the balance judges that the sample weight is too light to acquire accurate weighing data, it displays an error prompting the addition of more samples to the specified number.

Add the specified number of samples and press the **ENTER** key.

Refer to “12-2. Error Codes.”

- If the balance judges that the sample unit weight is too light and cannot be stored as the unit weight, it displays **Lo** and returns to the previous display.

Even in this situation, the unit weight may be stored using the function setting “*U_n in 1*” or “*U_n in 2*.” However, the counting results are for reference only.

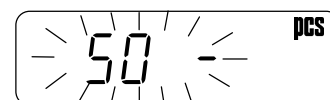

The displayed number will be stored as the number of samples.

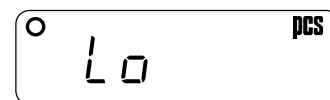

Objects to be counted

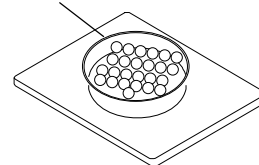

Counting the objects

7. Place the objects to be counted on the pan.
The balance counts the objects using the stored unit weight and displays the counting result.

Counting mode using the ACAI function

ACAI™ (Automatic Counting Accuracy Improvement) is a function that improves the accuracy of the unit weight by increasing the number of samples as the counting process proceeds.

8. If a few more samples are added to the sample in step 6 after the unit weight is stored, the ACAI indicator turns on.

Add the same number of samples as displayed. (The ACAI indicator will not turn on if overloaded.)

ACAI indicator

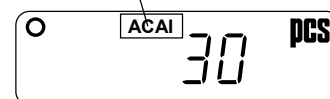

9. The balance re-calculates the unit weight while the ACAI indicator is blinking. Do not touch the balance or samples on the pan until the ACAI indicator turns off.
10. Counting accuracy is improved when the ACAI indicator turns off. Each time the above operation is performed, a more accurate unit weight will be obtained. There is no definite upper limit of ACAI range for the number of samples exceeding 100. Try to add the same number of samples as displayed.

7-7. Percent Mode (%)

Displays the weight value in percentage compared to the 100% reference weight.

Selecting the percent mode

1. Press the **MODE** key to select %. (%: percent)

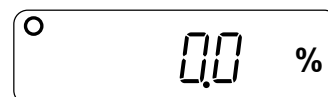

Storing the 100% reference weight

2. Press the **SAMPLE** key to enter the 100% reference weight storing mode.

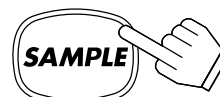

3. With nothing on the pan, press the **ZERO/ON:OFF** key to display 100 0%.



When using a tare (container), after the above operation, place the container on the pan and press the **TARE** key to display 100 0%.



4. Place the sample to be set as the 100% reference weight on the pan.

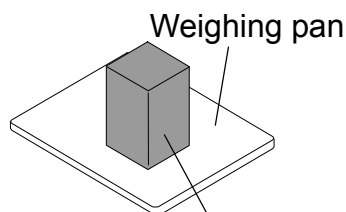

5. Press the **ENTER** key to store the 100% reference weight. Remove the sample.

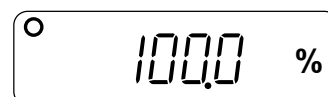

- If the balance judges that the sample weight is too light and cannot be stored as the 100% reference weight, it displays **Lo** and returns to the previous display.

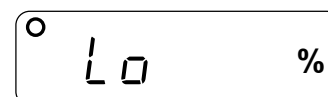

Reading the percentage

6. Place the object to be compared to the 100% reference weight on the pan. The displayed percentage is based on the 100% reference weight.

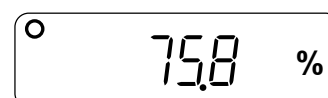
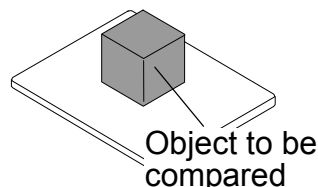

8. COMPARATOR

The results of the comparison are indicated by HI, OK or LO in the display.
The comparison is as follows:

$$LO < \text{Lower limit value} \leq OK \leq \text{Upper limit value} < HI$$

Comparison mode (Refer to the function setting “[P]”):

- No comparison (comparator function disabled).
- Compares all data.
- Compares all stable data.
- Compares plus data except those near zero (plus data greater than +5d).
- Compares stable plus data except those near zero (stable plus data greater than +5d).
- Compares all data except those near zero (all data greater than +5d or less than -5d).
- Compares stable data except those near zero (stable data greater than +5d or less than -5d).

d = minimum display division.

e.g.: “d” for the EK-300EP is 0.01 g. Therefore, 5d is 0.05 g.

The minimum display for the counting mode is 1 piece, for the percent mode, 0.1%.

The upper limit and lower limit values are common to each of the weighing, counting and percent mode.

Example	EK-300EP	EK-3000EP
Upper limit 001010	10.10 g / 1010 pcs / 101.0%	101.0 g / 1010 pcs / 101.0%
Lower limit 000990	9.90 g / 990 pcs / 99.0%	99.0 g / 990 pcs / 99.0%

8-1. Setting Example

To set “Compares plus data except those near zero (plus data greater than +5d).”

Selecting a comparison mode

1. Press and hold the **SAMPLE** key to display **Func**.
(If the comparison mode is already set, press the **SAMPLE** key to proceed to “Entering the upper and lower limit values.”)
2. Press the **ENTER** key to display **PoFF X**.
(X=0 or 1.)
3. Press the **SAMPLE** key several times to display **[P X]**.
(X=0 to 5.)

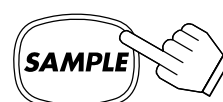

Press and hold

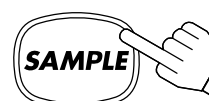
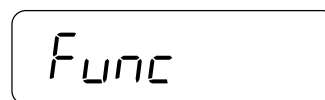

Press several times

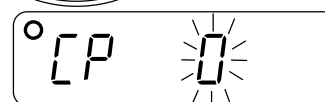

- Press the **TARE** key several times to display **[CP 3]**.
- Press the **ENER** key to store the setting. **[CP H,]** appears after **[End]**.

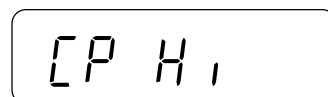
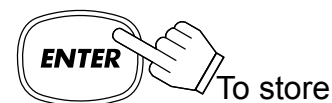
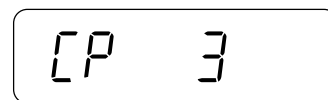

Set using the relevant keys

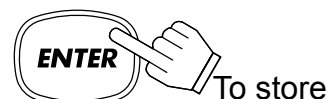
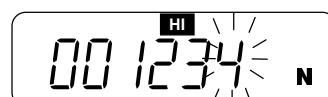

Entering the upper and lower limit values

- With **[CP H,]** displayed, press the **ENTER** key. Enter the upper limit value using the following keys.

[SAMPLE] key To select the digit to change the value (blinking).

[TARE] key To change the value of the blinking digit. Hold down the key to switch the polarity. ("N" means negative.)

ENTER key To store the value and proceed to the next step.

[MODE] key To cancel the operation and proceed to the next step.

- With **[CP Lo]** displayed, press the **ENTER** key. Enter the lower limit value using the following keys.

[SAMPLE] key To select the digit to change the value (blinking).

[TARE] key To change the value of the blinking digit. Hold down the key to switch the polarity. ("N" means negative.)

ENTER key To store the value and proceed to the next step.

[MODE] key To cancel the operation and proceed to the next step.

- Press the **ENTER** key. **[Unit]** appears after **[End]**.

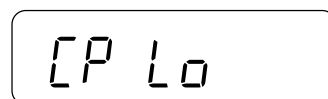

Set using the relevant keys

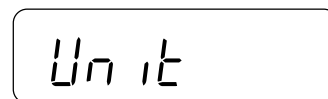
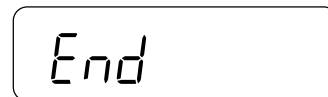
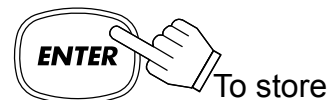
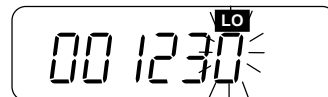

Returns to the weighing mode

- Press the **[MODE]** key to return to the weighing mode.

9. CALIBRATION

This function adjusts the balance for accurate weighing.
Perform calibration in the following cases.

- When the balance is first used.
- When the balance has been moved.
- When the ambient environment has changed.
- For regular calibration.

Press and slide the calibration switch cover down.

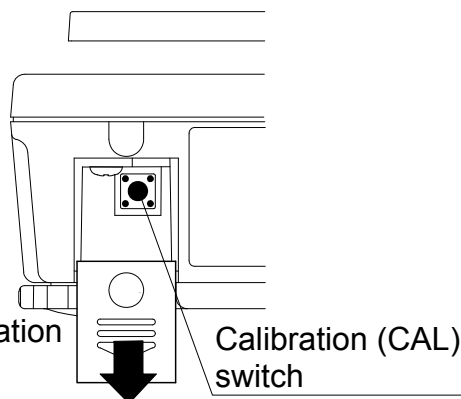

9-1. Calibration Using a Weight

- Prepare a calibration weight (sold separately) in advance.
A calibration weight with a value of 1/2 of the weighing capacity or more is recommended.

1. Warm up the balance for at least half an hour with nothing on the pan.
2. Press and hold the calibration (CAL) switch until CAL appears, and release the switch.
3. The balance displays CAL 0.

To change the calibration weight value, proceed to step 4.

To use the calibration weight value in the balance memory, proceed to step 5.

4. Press the SAMPLE key. The balance displays the calibration weight value in “gram” that is stored in the balance. Use the following keys to change the value.

- | | |
|------------------------------------------------------------------------|-----------------------------------------------------|
| SAMPLE key | To select the digit to change the value (blinking). |
| TARE key | To change the value of the blinking digit |
| ENTER key | To store the value and proceed to step 5. |
| UNITS key | To cancel the operation and return to step 3. |

 Press and hold the CAL switch.

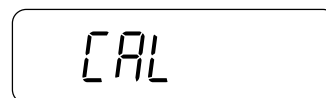

Release the CAL switch.

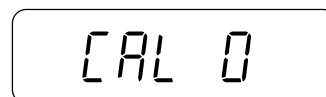

Set the weight using the relevant keys.

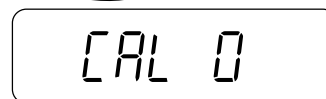

5. With **CAL 0** displayed, press the **ENTER** key to calibrate the zero point. Do not touch the pan during zero calibration.

When zero calibration has been completed, the balance displays the calibration weight value.

- ❑ If span calibration is not to be performed, press the **MODE** key or CAL switch to return to the weighing mode.

6. Place a calibration weight with the same value as displayed on the pan. Press the **ENTER** key to perform span calibration. Do not touch the pan during span calibration.

7. **End** appears.
Remove the weight from the pan.
Press the CAL switch or **MODE** key to return to the weighing mode.

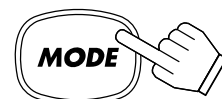
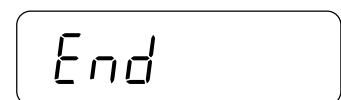
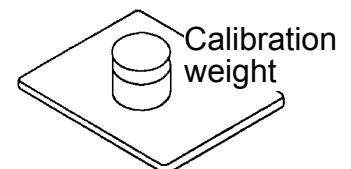
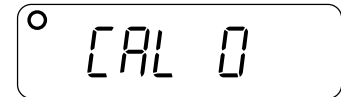
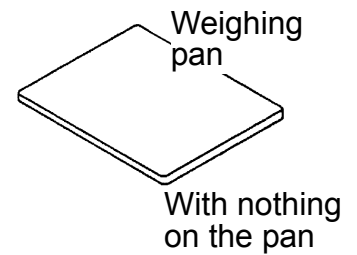

Returns to the weighing mode

❑ **Note**

The value set in step 4 is stored in memory even after the power is turned OFF.

If the balance is to be moved to other places, set the gravity acceleration value of the area where calibration using a weight is to be performed, and calibrate the balance according to the procedure above. Refer to the next section to set the gravity acceleration value.

9-2. Gravity Acceleration Correction

When the balance is first used or has been moved to a different place, it should be calibrated using a calibration weight.

But if a calibration weight is not available, the gravity acceleration correction will compensate the balance. Change the gravity acceleration value of the balance to the value of the area where the balance will be used. Refer to the gravity acceleration map appended to the end of this manual.

□ Note

Gravity acceleration correction is not required when the balance is calibrated using a calibration weight at the place where the balance is to be used.

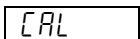
1. Press and hold the calibration (CAL) switch until  appears, and release the switch.

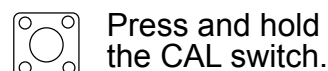

Press and hold the CAL switch.

2. The balance displays .

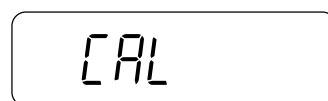



Release the CAL switch.

3. Press the  key.

The balance displays the gravity acceleration value stored in the balance.

Use the following keys to change the value.

 key To select the digit to change the value (blinking).

 key To change the value of the blinking digit.

 key To store the value and proceed to step 4.

 key To cancel the operation and return to step 2.

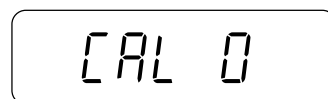

Set the value using the relevant keys.

4. Press the  key to store the value.

 appears.

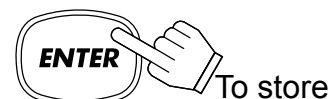

To store

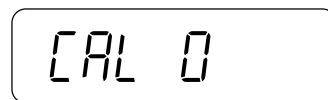

5. If it is necessary to calibrate the balance using a calibration weight, proceed to step 3 of 8-1.

6. To finish the setting, press the  key.

The balance returns to the weighing mode.

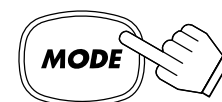

Returns to the weighing mode

10. FUNCTIONS

10-1. Key Operation

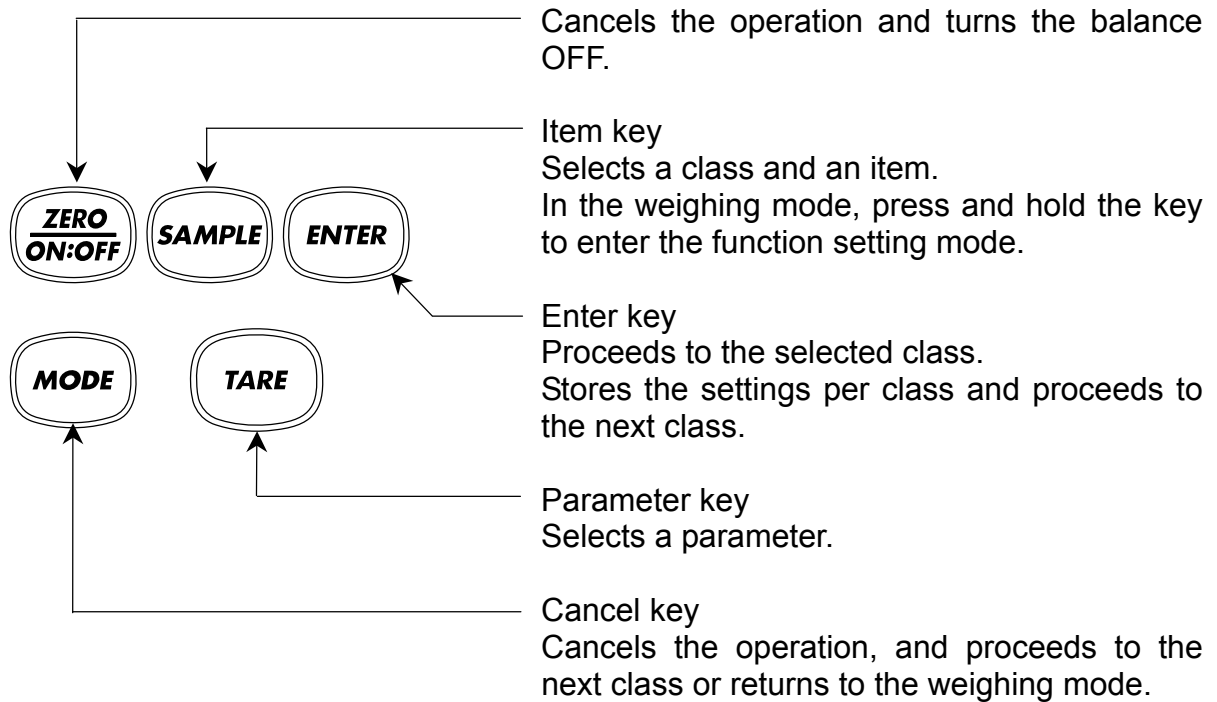

10-2. Entering the Function Setting Mode

In the weighing mode, press and hold the **SAMPLE** key to enter the function setting mode and display **Func**.

Each time the **SAMPLE** key is pressed, the classes appear one after another.

For details on functions, refer to “10-5. Function List.”

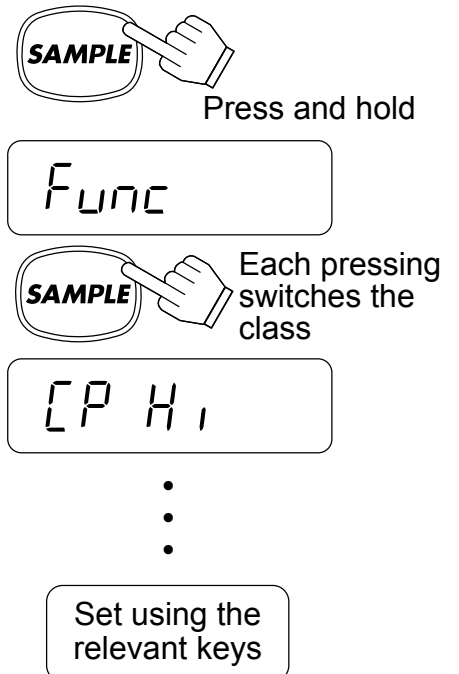

10-3. Setting Example

To set the auto power-off function to “Disabled”, and the ACAI function to “Disabled.”

1. Press and hold the **SAMPLE** key to display **Func**.

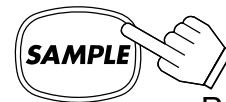

Press and hold

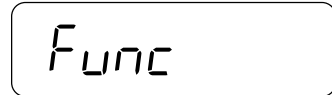

2. Press the **ENTER** key to display **PoFF 1**.



3. Press the **TARE** key to display **PoFF 0**.



Each pressing switches the parameters

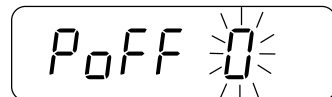

4. Press the **SAMPLE** key several times to display **ACA, 1**.

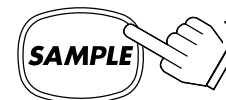

To confirm

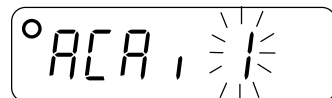

5. Press the **TARE** key to select **ACA, 0**.



Each pressing switches the parameters

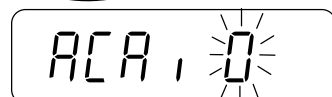

6. Press the **ENTER** key to store the parameter. **[P H,]** appears after **End**.



To store

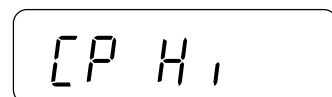
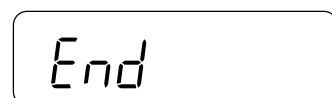

7. Press the **MODE** key to return to the weighing mode.



Returns to the weighing mode

10-4. Storing Weighing Units

It is possible to store the weighing units that will actually be used from the units available. For the units available, Refer to “7-3. Units.”
Select and store the weighing units as described below:

1. Press and hold the **SAMPLE** key to display **Func**.

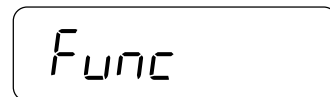

2. Press the **SAMPLE** key several times to display **Unit**.

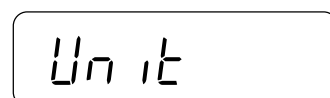

3. Press the **ENTER** key.

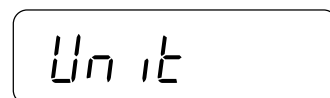

4. Press the **SAMPLE** key to select a weighing unit.

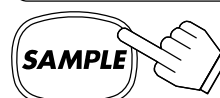

Each pressing switches the units available in the order described in 7-3.

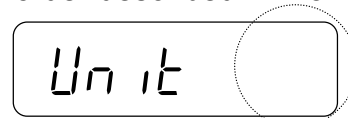

5. Press the **TARE** key to confirm the weighing unit.



6. Repeat steps 4 and 5 to confirm all the weighing units to be used.

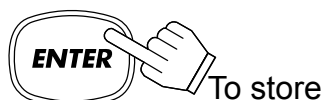

7. Press the **ENTER** key to store the confirmed weighing units in memory. **Func** appears after **End**.

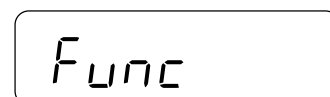
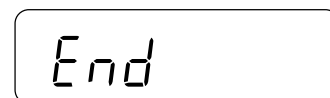

8. Press the **MODE** key to return to the weighing mode.

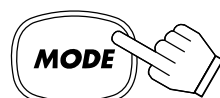

Returns to the weighing mode

□ Note

When the balance is turned ON, it starts with the unit that was confirmed first in step 5.

10-5. Function List

Class	Item	Parameter	Description	
<i>F_{UNC}</i>	<i>P_{OFF}</i> Auto power-off	0	Auto power-off disabled	Turns the power OFF automatically
		◆ 1	Auto power-off enabled	
	<i>[<i>OND</i>]</i> Response	0	Fast / sensitive ↕ Slow / stable	Good environment/ Target weighing ↕ Priority on stability
		1		
		◆ 2		
		3		
		4		
	<i>[<i>St-b</i>]</i> Stability band width	0	Stable when within ± 0.5d/0.5 s	Conditions to turn the STABLE indicator on
		◆ 1	Stable when within ± 1d/0.5 s	
		2	Stable when within ± 2d/0.5 s	
	<i>[<i>TRC</i>]</i> Zero tracking	0	Disabled	Tracks the zero drift
		◆ 1	Enabled	
	<i>[<i>Pnt</i>]</i> Decimal point	◆ 0	Point (.)	Decimal point format
		1	Comma (,)	
	<i>[<i>P</i>]</i> Comparison mode	◆ 0	Comparator function disabled	Conditions to compare. d = minimum display division
		1	Compares all data	
		2	Compares all stable data	
		3	Compares plus data > +5d	
		4	Compare stable plus data > +5d	
		5	Compares data > +5d or < -5d	
	<i>[<i>RCR</i>]</i> ACAI function	0	ACAI disabled	0: no additional samples
		◆ 1	ACAI enabled	
	<i>[<i>Min</i>]</i> Minimum unit weight acceptable	◆ 0	Unit weight ≥ 1d	d = minimum display division
		1	Unit weight ≥ 1/10d	
		2	Total sample weight ≥ 5d (*)	
	<i>[<i>nPL</i>]</i> Number of samples	◆ 0	10 pcs	The number of samples displayed first when entered into the unit weight storing mode
		1	25 pcs	
		2	50 pcs	
		3	100 pcs	
		4	5 pcs	
<i>[<i>LtUP</i>]</i> LCD Backlight control	0	Always off	Conditions to turn the LCD backlight on/ off. Weight change or key operation Stable = STABLE indicator on	
	1	Turns off 3 seconds after stable		
	2	Turns off 10 seconds after stable		
	◆ 3	Turns off 30 seconds after stable		
	4	Turns off 60 seconds after stable		
5	Always on			
<i>[<i>PH</i>]</i>	Comparator upper limit		Sets the upper limit value	Refer to "8. COMPARATOR"
<i>[<i>PL</i>]</i>	Comparator lower limit		Sets the lower limit value	
<i>[<i>Unit</i>]</i>	Weighing units to be displayed		Sets units to be displayed	Refer to "10-4. Storing Weighing Units"

◆ Factory setting

(*) Even if the weight display is "5d", the sample weight may not be accepted. This is because the weight display data is rounded off internally.

11. OPTION

As an option, a carrying case (EJ-12) is available for carrying the balance by hand. Please note that the balances are precision equipment and they, even placed in the case, will not be able to withstand excessive shock, such as being dropped. Therefore, use much care when carrying the balance.

12. MAINTENANCE

12-1. Notes on Maintenance

-  **WARNING**
- Do not disassemble the balance.
 - Use the original packing material for transportation.
 - Do not use organic solvents to clean the balance. Use a lint free cloth moistened with warm water and a mild detergent.

12-2. Error Codes

Overload error

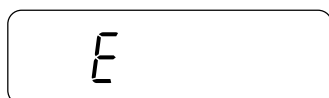

An object beyond the balance capacity has been placed on the pan.
Remove the object from the pan.

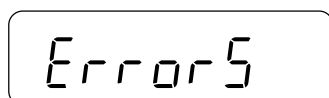

The balance has detected an erroneous loading condition.
Remove the object from the pan or take other necessary measures to set the balance condition to normal.

Range exceeding error

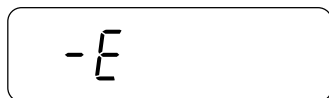

The balance has detected an excessive upward force.
Check if there is anything trapped under the edge of the weighing pan. There is a possibility that the weighing sensor itself may have a failure.

Unit weight error

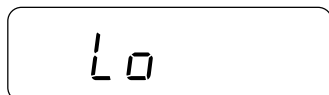

The sample weight is too light to be used as the unit weight in the counting mode or 100% reference weight in the percent mode.

Sample quantity error



When the total sample weight is light and the counting error could become large, the balance prompts you to use larger number of samples.

Place the displayed number of samples on the pan and press the **ENTER** key to store the unit weight.

Note: Pressing the **ENTER** key without adding samples is possible, but that will reduce counting accuracy.

When starting from the 100 samples, **100 -** may be displayed if the sample weight is light. Under the situation, press the **ENTER** key without adding any samples.

When the function setting "ACR, 0" (ACAI disabled) or "Unit in 2" is selected, this error will not appear.

CAL errors

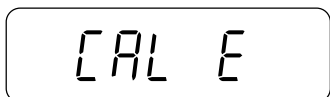
A rectangular display box containing the text "CAL E" in a digital font.

Calibration has been canceled because the calibration weight is too heavy.

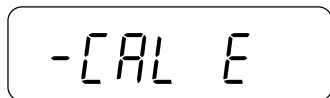
A rectangular display box containing the text "-CAL E" in a digital font.

Calibration has been canceled because the calibration weight is too light.

Check the weighing pan and the calibration weight.
To return to the weighing mode, press the **MODE** key.

Low battery error

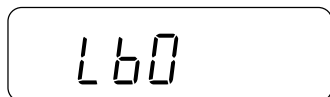
A rectangular display box containing the text "Lb0" in a digital font.

The batteries are exhausted.
Stop using the balance immediately and replace all four batteries with new ones

Stability error

A rectangular display box containing the text "Error 1" in a digital font.

The weight value is not stable and the balance cannot perform the operation when keys such as **ZERO/ON:OFF** or **TARE** are pressed.
Prevent vibration and drafts from influencing the balance.
Press the **MODE** key to return to the weighing mode.

Internal error (# = 2 to 5)

A rectangular display box containing the text "Error #" in a digital font.

The balance has detected an error in the internal processing.
Remove the object from the pan. Turn the power OFF, and ON again.
If the error persists, request service.

If you cannot resolve an error or other errors occur, request service from the store where you purchased the balance or from your local A&D dealer.

13. SPECIFICATIONS

13-1. Specifications

MODEL	EK-300EP	EK-3000EP	EK-12KEP
Explosion-proof structure	Ex ia IIB T3		
Ambient temperature range	-25°C to 40°C / -13°F to 104°F		
Weighing capacity	300 g	3000 g	12 kg
Minimum display "d"	0.01 g	0.1 g	1 g
Repeatability (Std. deviation)	0.01 g	0.1 g	1 g
Linearity	±0.02 g	±0.2 g	±1 g
Sensitivity drift	±20 ppm / °C (10°C to 30°C / 50°F to 86°F)		
Number of samples	5, 10, 25, 50 or 100 pieces		
Maximum count *	30,000 pcs	30,000 pcs	12,000 pcs
Minimum unit weight *	0.01 g	0.1 g	1 g
Minimum % display	0.1 %		
Minimum 100 % weight	1 g	10g	100 g
Display	7 segment LCD with backlight (Character height 16 mm)		
Display update	Approx. 10 times per second		
Operating temperature and humidity range	0°C to 40°C / 32°F to 104°F, Less than 85% R.H. (non-condensing)		
Power source	6.0 VDC, Four "AA", "LR6" or "AM3" batteries Operating hours: Approx. 250 hours with backlight off		
Weighing pan size	110 mm ø	133 x 170 mm	
Weight (Excluding batteries)	Approx. 1.2 kg	Approx. 1.5 kg	Approx. 1.5 kg
Calibration weight (factory setting)	300 g	3000 g	10 kg

* In case of "Unit in g" (factory setting)

13-2. Option

EJ-12 Carrying case

13-3. External Dimensions

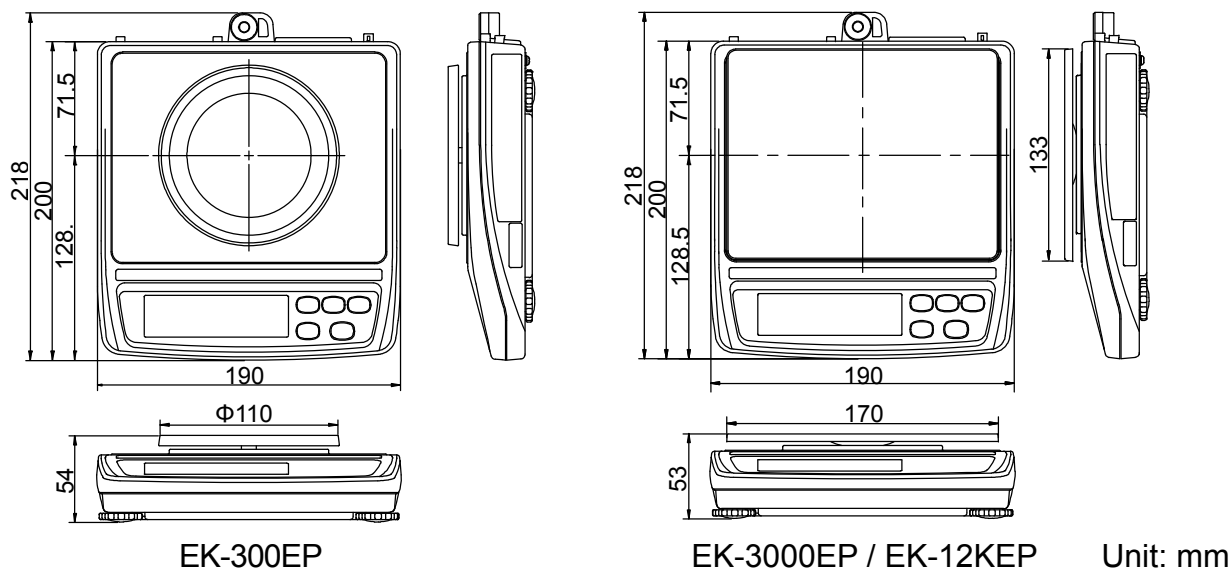

13-4. Other Weighing Units

	MODEL	EK-300EP	EK-3000EP	EK-12KEP
oz	Weighing capacity	10.935	109.35	423.3
	Minimum display	0.001	0.01	0.1
lb	Weighing capacity	0.6834	6.834	26.46
	Minimum display	0.0001	0.001	0.01
ozt	Weighing capacity	9.967	99.67	385.8
	Minimum display	0.001	0.01	0.1
ct	Weighing capacity	1500.00	—	—
	Minimum display	0.05	—	—
mom	Weighing capacity	82.665	826.65	3200
	Minimum display	0.005	0.05	0.5
dwt	Weighing capacity	199.33	1993.3	7716
	Minimum display	0.01	0.1	1
GN	Weighing capacity	4784.0	47840	—
	Minimum display	0.2	2	—
tola**	Weighing capacity	26.578	265.78	1028.8
	Minimum display	0.001	0.01	0.1
tl (HG)**	Weighing capacity	8.2010	82.010	317.45
	Minimum display	0.0005	0.005	0.05
tl (HJ)**	Weighing capacity	8.2825	82.825	320.6
	Minimum display	0.0005	0.005	0.05
tl (T)**	Weighing capacity	8.2665	82.665	320
	Minimum display	0.0005	0.005	0.05

****The unit “tola” and three kinds of “tl” are for special versions only and one of them will be available.**

tl (HG): Hong Kong General / Singapore tael

tl (HJ): Hong Kong Jewelry tael

tl (T): Taiwan tael

GRAVITY ACCELERATION MAP

Values of Gravity at Various Locations

Amsterdam	9.813 m/s ²	Manila	9.784 m/s ²
Athens	9.807 m/s ²	Melbourne	9.800 m/s ²
Auckland NZ	9.799 m/s ²	Mexico City	9.779 m/s ²
Bangkok	9.783 m/s ²	Milan	9.806 m/s ²
Birmingham	9.813 m/s ²	New York	9.802 m/s ²
Brussels	9.811 m/s ²	Oslo	9.819 m/s ²
Buenos Aires	9.797 m/s ²	Ottawa	9.806 m/s ²
Calcutta	9.788 m/s ²	Paris	9.809 m/s ²
Cape Town	9.796 m/s ²	Rio de Janeiro	9.788 m/s ²
Chicago	9.803 m/s ²	Rome	9.803 m/s ²
Copenhagen	9.815 m/s ²	San Francisco	9.800 m/s ²
Cyprus	9.797 m/s ²	Singapore	9.781 m/s ²
Djakarta	9.781 m/s ²	Stockholm	9.818 m/s ²
Frankfurt	9.810 m/s ²	Sydney	9.797 m/s ²
Glasgow	9.816 m/s ²	Taichung	9.789 m/s ²
Havana	9.788 m/s ²	Tainan	9.788 m/s ²
Helsinki	9.819 m/s ²	Taipei	9.790 m/s ²
Kuwait	9.793 m/s ²	Tokyo	9.798 m/s ²
Lisbon	9.801 m/s ²	Vancouver, BC	9.809 m/s ²
London (Greenwich)	9.812 m/s ²	Washington DC	9.801 m/s ²
Los Angeles	9.796 m/s ²	Wellington NZ	9.803 m/s ²
Madrid	9.800 m/s ²	Zurich	9.807 m/s ²

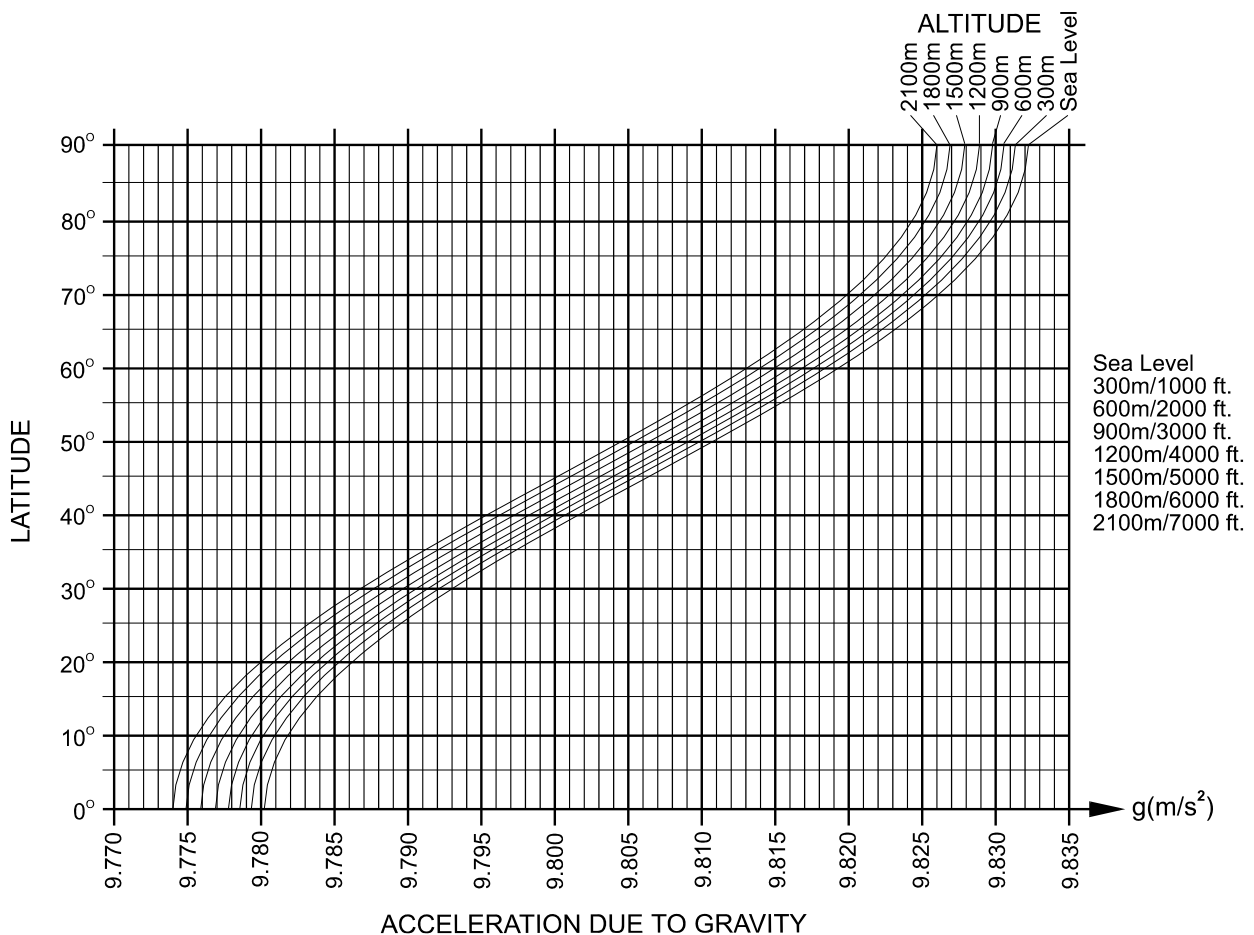

World Map

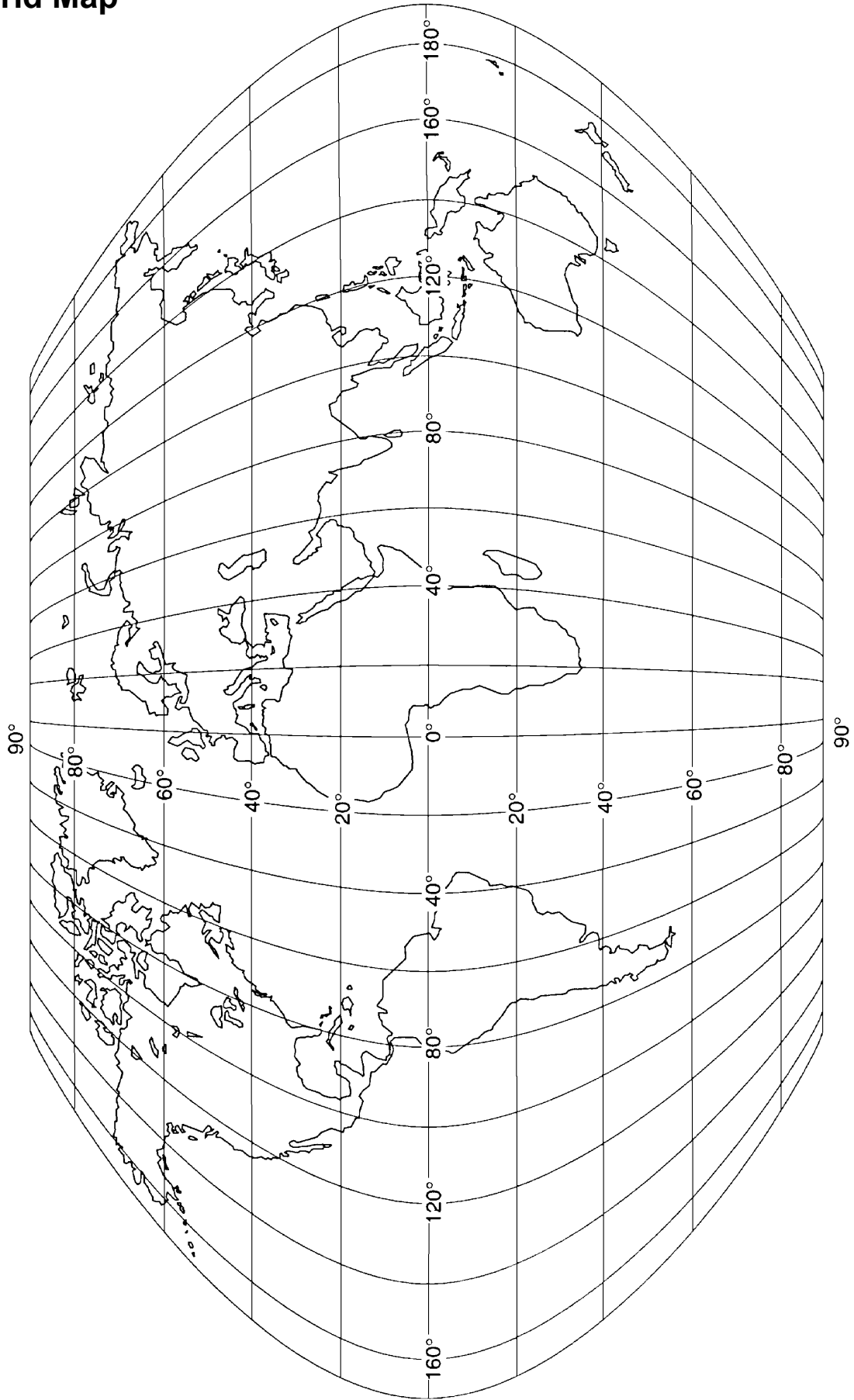



A&D Company, Limited

3-23-14 Higashi-Ikebukuro, Toshima-ku, Tokyo 170-0013, JAPAN
Telephone: [81] (3) 5391-6132 Fax: [81] (3) 5391-6148

A&D ENGINEERING, INC.

1756 Automation Parkway, San Jose, California 95131, U.S.A.
Telephone: [1] (408) 263-5333 Fax: [1] (408)263-0119

A&D INSTRUMENTS LIMITED

Unit 24/26 Blacklands Way, Abingdon Business Park, Abingdon, Oxfordshire OX14 1DY United Kingdom
Telephone: [44] (1235) 550420 Fax: [44] (1235) 550485

A&D AUSTRALASIA PTY LTD

32 Dew Street, Thebarton, South Australia 5031, AUSTRALIA
Telephone: [61] (8) 8301-8100 Fax: [61] (8) 8352-7409

A&D KOREA Limited

한국에이.엔.디(주)
서울특별시 영등포구 국제금융로6길33 (여의도동) 맨하탄빌딩 817 우편 번호 150-749
(817, Manhattan Bldg., 33. Gukjegeumyung-ro 6-gil, Yeongdeungpo-gu, Seoul, 150-749 Korea)
전화: [82] (2) 780-4101 팩스: [82] (2) 782-4280

ООО A&D RUS

ООО "ЭЙ энд ДИ РУС"
121357, Российская Федерация, г.Москва, ул. Вереysкая, дом 17
(Business-Center "Vereyskaya Plaza-2" 121357, Russian Federation, Moscow, Vereyskaya Street 17)
тел.: [7] (495) 937-33-44 факс: [7] (495) 937-55-66

A&D INSTRUMENTS INDIA PRIVATE LIMITED

ऐ&डी इन्स्ट्रुमेन्ट्स इण्डिया प्रा० लिमिटेड
509, उद्योग विहार, फेस -5, गुडगांव - 122016, हरियाणा, भारत
(509, Udyog Vihar, Phase-V, Gurgaon - 122 016, Haryana, India)
फोन : 91-124-4715555 फैक्स : 91-124-4715599